

# 2013年

# 大中華地區產品型錄

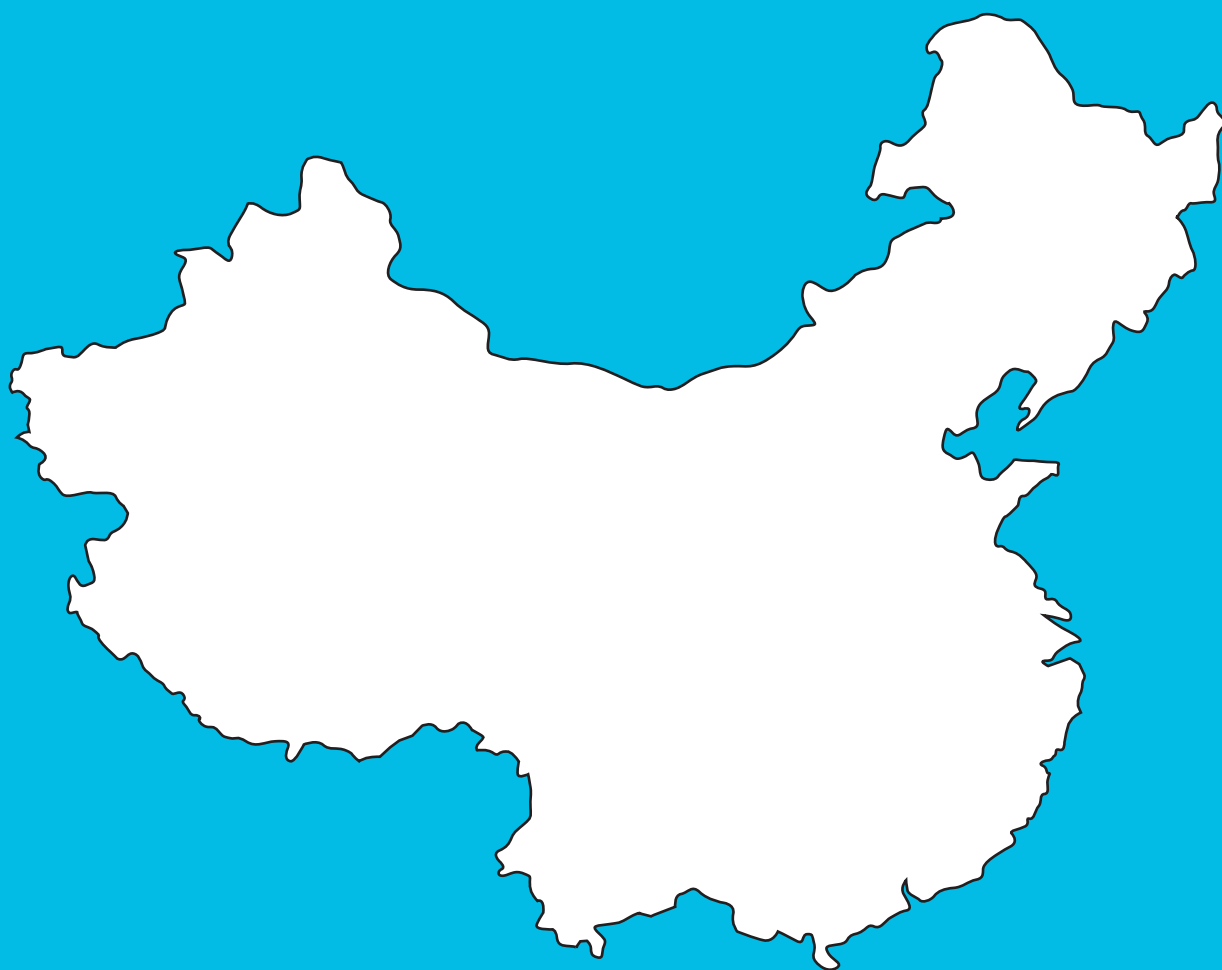



# LED T-BAR

Low power consumption, energy save and green.  
 Special and different visual angle, diversified design.  
 Lighting up immediately, no flickering, no noisy and no glare.  
 Built-in highly protection system. Under non-steady voltage condition, constant current driving will ensure the lamp working normally.  
 Special circuits design to ensure every LED working independently and won't be affected by any broken LEDs.  
 No electromagnetic wave, zero lead, mercury and other harmful.



DL-13011 L600mm W600mm  
 DL-13012 L600mm W600mm

產品型號	功率 (w)	亮度 (Lm)	色溫	材質	輸入電壓	芯片	工作壽命	功率因數
DL-13011	36	2800~3200	6000K	PC + Aluminium	AC100-240V /DC24V	LRU	30,000Hr	>90%
DL-13012	48	3500~3800	6000K	PC + Aluminium	AC100-240V /DC24V	LRU	30,000Hr	>90%

# LED T-BAR



SIZE:L600mm W600mm H32mm

## ◆ 產品特點

- 1- 低消耗功率，節能環保。Low power consumption,energy sace and green.
- 2- 特殊的不同視覺角度，設計多元化。Special and different cisual angel,dicersified desing.
- 3- 瞬間啓動，無炫光，無鳴音。Lighting up immediately,no flichering,no noisy and no glare.
- 4- 內置高效保護系統，在電壓不穩定的情況下恆流驅動仍能保證板面燈正常工作。Built-in highly protection system. Under non-steady voltage condition,constant current dticing will ensure the lamp working normally.
- 5- 特殊的電路設計，確保每個 LED 獨立工作，單顆 LED 損壞不會有任何影響。Special ciruits desing to ensure every LED working independently and won't be affected by any broken LEDs.
- 6- 無電磁波，無汞、鉛等危害人體及環境的有害物質。No electromagnetic wave □zero lead□mercury and other harmful.

產品型號	功率 (w)	亮度 (Lm)	色溫	材質	輸入電壓	光源	工作壽命	功率因數
DL-13021	33	2400	5700K	PC + Iron	AC100-240V /DC24V	光 宏	30,000Hr	>85%



DL-13031 L600mm W600mm  
DL-13032 L600mm W600mm

產品型號	功率 (w)	亮度 (Lm)	色溫	材質	輸入電壓	芯片	工作壽命	功率因數
DL-13031	36	2800~3200	6000K	PC + Aluminium	AC100-240V /DC24V	LRU	30,000Hr	>90%
DL-13032	48	3500~3800	6000K	PC + Aluminium	AC100-240V /DC24V	LRU	30,000Hr	>90%

# LED T-BAR



SIZE:L600mm W600mm

## ◆ 產品特點

- 1- 低消耗功率，節能環保。Low power consumption, energy save and green.
- 2- 特殊的不同視覺角度，設計多元化。Special and different visual angle, diversified design.
- 3- 瞬間啟動，無炫光，無鳴音。Lighting up immediately, no flickering, no noisy and no glare.
- 4- 內置高效保護系統，在電壓不穩定的情況下恆流驅動仍能保證板面燈正常工作。Built-in highly protection system. Under non-steady voltage condition, constant current driving will ensure the lamp working normally.
- 5- 特殊的電路設計，確保每個 LED 獨立工作，單顆 LED 損壞不會有任何影響。Special circuits design to ensure every LED working independently and won't be affected by any broken LEDs.
- 6- 無電磁波，無汞、鉛等危害人體及環境的有害物質。No electromagnetic wave □ zero lead □ mercury and other harmful.

產品型號	功率 (w)	亮度 (Lm)	色溫	材質	輸入電壓	芯片	工作壽命	功率因數
DL-13041	50	4200	5700K	PC + Iron	AC100-240V /DC24V	晶元	30,000Hr	>90%



DL-13051  
H150mm

DL-13052  
H130mm

DL-13053  
H110mm

DL-13054  
H90mm

產品型號 Model	DL-13051	DL-13052	DL-13053	DL-13054
燈具功率 LED power	15W	11W	7W	5W
輸入電壓 Input Voltage	AC100~240V	AC100~240V	AC100~240V	AC100~240V
顯色指數 Color Rendering Index	Ra≥80	Ra≥80	Ra≥80	Ra≥80
色溫 Color.t	3000~6000K	3000~6000K	3000~6000K	3000~6000K
外殼材質 Case Material	鋁材 Aluminum	鋁材 Aluminum	鋁材 Aluminum	鋁材 Aluminum
發光顏色 Emitting color	白光 / 暖白	白光 / 暖白	白光 / 暖白	白光 / 暖白

# SMD LED T8 FLUORESCENT

SMD LED T8 日光燈



產品型號 Model	DL-13061	DL-13062
規格 Specification	T8 LED 日光燈 60CM	T8 LED 日光燈 120CM
上蓋 Lid	霧面 Fuzzy surface	霧面 Fuzzy surface
顏色 Color	白光 / 暖白光	白光 / 暖白光
光通量 Luminaire	1080lm	2160lm
發光角度 Beam angle	120°	120°
色溫 Color.t	3000~6000K	3000~6000K
電壓 Voltage	AC100V~240V	AC100V~240V
功率 Power	9W	18W
使用壽命 Lifespan(HRS)	≥50,000Hrs	≥50,000Hrs
顯色指數 Color Rendering Index	Ra≥80	Ra≥80
尺寸 Size	600mm	1200mm
材質 Material	鋁材 / 壓克力 Aluminum/ Acrylic	
適用範圍 A.scope	廣告招牌、醫院、商場、學校等建築照明 Construction lighting(advertising signs,hospital,suoermarket,school)	

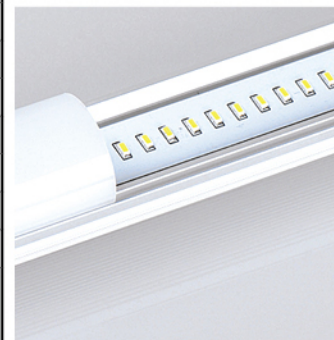

# SMD LED T5 PLATE LAMPS

SMD LED T5 層板燈



產品型號 Model	DL-13071	DL-13072
規格 Specification	T5 LED 層板燈 60CM	T5 LED 層板燈 120CM
上蓋 Lid	霧面 Fuzzy surface	霧面 Fuzzy surface
顏色 Color	白光 / 暖白光	白光 / 暖白光
光通量 Luminaire	900lm	1800lm
發光角度 Beam angle	120°	120°
色溫 Color.t	3000~6000K	3000~6000K
電壓 Voltage	AC100V~240V	AC100V~240V
功率 Power	9W	18W
使用壽命 Lifespan(HRS)	≥50,000Hrs	≥50,000Hrs
顯色指數 Color Rendering Index	Ra≥80	Ra≥80
尺寸 Size	600mm	1200mm
材質 Material	鋁材 / 壓克力 Aluminum/ Acrylic	
適用範圍 A.scope	廣告招牌、醫院、商場、學校等建築照明 Construction lighting(advertising signs,hospital,suoermarket,school)	





# SMD LED T8 PLATE LAMPS

SMD LED T8 層板燈



產品型號 Model	DL-13081	DL-13082
規格 Specification	T8 LED 層板燈 60CM	T8 LED 層板燈 120CM
上蓋 Lid	霧面 Fuzzy surface	霧面 Fuzzy surface
顏色 Color	白光 / 暖白光	白光 / 暖白光
光通量 Luminaire	1080lm	2160lm
發光角度 Beam angle	120°	120°
色溫 Color.t	3000~6000K	3000~6000K
電壓 Voltage	AC100V~240V	AC100V~240V
功率 Power	9W	18W
使用壽命 Lifespan(HRS)	≥50,000Hrs	≥50,000Hrs
顯色指數 Color Rendering Index	Ra≥80	Ra≥80
尺寸 Size	600mm	1200mm
材質 Material	鋁材 / 壓克力 Aluminum/ Acrylic	
適用範圍 A.scope	廣告招牌、醫院、商場、學校等建築照明 Construction lighting(adcertising signs,hospital,suoermarket,school)	



# LED FULL COOR LIGHT CUP

LED 幻彩燈杯



## ◆ 產品特點

採用臺灣大晶片安全可靠  
AC 定電流專用電源  
無熱輻射、紫外線、永保產品亮麗、不褪色  
鋁合金散熱片外殼，散熱效果極佳，壽命長  
採用平面光學透鏡，使光綫更柔和  
LED 取代傳統滷素燈具，壽命是傳統的 8 倍  
適合空間：精品展示、畫廊、珠寶櫥櫃、飯店、餐廳、情境照明、居家重點照明等



附帶遙控器

## ◆ Product characteristics

Adopting Taiwan Epistar Chip, more reliable  
AC constant current power supply  
No thermal radiation, no UV, Keep bright color for ever  
Aluminum alloy heat sink shell, superior effects, long lifespan  
Plane optical lens reflects softer rays of light  
LED replaces traditional halogen lamps, the lifespan is 8 times of the latter  
Application: Boutique showcase, art gallery, jewelry cabinet, restaurant and dining room, situation lighting, home accent lighting, etc..

產品型號 Model	DL-13091
燈具功率 LED power	6W
輸入電壓 Input Voltage	AC100~240V / 50~60Hz
顯色指數 Color Rendering Index	Ra≥80
色溫 Color.t	3000~6000K
外殼材質 Case Material	鋁材 Aluminum
發光顏色 Emitting color	七彩 RGB

# LED MR 16 LIGHT CUP

LED MR16



DL-13101



DL-13102



DL-13103



DL-13104



DL-13105  
Ø105mm 嵌孔 93mm



DL-13106  
Ø105mm 嵌孔 93mm



DL-13107  
Ø90mm 嵌孔 80mm

產品型號 Model	DL-13101	DL-13102	DL-13103	DL-13104
燈具功率 LED power	4W	4W	5W	5W
輸入電壓 Input Voltage	AC/ DC12V	AC/ DC12V	AC/ DC12V	AC/ DC12V
顯色指數 Color Rendering Index	Ra≥80	Ra≥80	Ra≥80	Ra≥80
色溫 Color.t	3000~6000K	3000~6000K	3000~6000K	3000~6000K
外殼材質 Case Material	鋁材 Aluminum	鋁材 Aluminum	鋁材 Aluminum	鋁材 Aluminum
發光顏色 Emitting color	白光 / 暖白	白光 / 暖白	白光 / 暖白	白光 / 暖白



免變壓器



DL-13111



DL-13112



DL-13113

產品型號 Model	DL-13111	DL-13112	DL-13113
燈具功率 LED power	3.5W	3W	4W
輸入電壓 Input Voltage	AC100~240V	AC100~240V	AC100~240V
顯色指數 Color Rendering Index	Ra≥80	Ra≥80	Ra≥80
色溫 Color.t	3000~6000K	3000~6000K	3000~6000K
外殼材質 Case Material	鋁材 Aluminum	鋁材 Aluminum	鋁材 Aluminum
發光顏色 Emitting color	白光 / 暖白	白光 / 暖白	白光 / 暖白

# LED BULB LIGHT

LED 燈泡



## ◆ 產品特點

採用臺灣大晶片安全可靠  
 AC 定電流專用電源  
 無熱輻射、紫外線、永保產品亮麗、不褪色  
 鋁合金散熱片外殼，散熱效果極佳，壽命長  
 採用平面光學透鏡，使光線更柔和  
 LED 取代傳統鹵素燈具，壽命是傳統的 8 倍  
 適合空間：精品展示、畫廊、珠寶櫥櫃、飯店、  
 餐廳、情境照明、居家重點照明等

## ◆ Product characteristics

Adopting Taiwan Epistar Chip, more reliable  
 AC constant current power supply  
 No thermal radiation, no UV, Keep bright color for ever  
 Aluminum alloy heat sink shell, superior effects, long lifespan  
 Plane optical lens reflects softer rays of light  
 LED replaces traditional halogen lamps, the lifespan is 8 times of the latter  
 Application: Boutique showcase, art gallery, jewelry cabinet, restaurant and dining room, situation lighting, home accent lighting, etc..



DL-13121  
 Ø55mm H100mm



DL-13122  
 Ø61mm H105mm

產品型號 Model	DL-13121	DL-13122
燈具功率 LED power	8W	7W
輸入電壓 Input Voltage	AC100~240V / 50~60Hz	AC100~240V / 50~60Hz
顯色指數 Color Rendering Index	Ra≥80	Ra≥80
色溫 Color.t	3000~6000K	3000~6000K
外殼材質 Case Material	鋁材 Aluminum	鋁材 Aluminum
發光顏色 Emitting color	白光 /W 暖白 /WW	白光 /W 暖白 /WW

# LED BULB LIGHT

LED 燈泡



DL-13131



DL-13132



DL-13133



DL-13134



## Product characteristics

Adopting Taiwan Epistar Chip, more reliable  
 AC constant current power supply  
 No thermal radiation, no UV, Keep bright color for ever  
 Aluminum alloy heat sink shell, superior effects, long lifespan  
 Plane optical lens reflects softer rays of light  
 LED takes place of traditional halogen lamps, the lifespan is 8 times of the latter  
 Application: Boutique showcase, art gallery, jewelry cabinet, restaurant and dining room, situation lighting, home accent lighting, etc..

產品型號 Model	DL-13131	DL-13132	DL-13133	DL-13134
燈具功率 LED power	4W	7W	8W	8W
輸入電壓 Input Voltage	AC100~240V	AC100~240V	AC100~240V	AC100~240V
顯色指數 Color Rendering Index	Ra≥80	Ra≥80	Ra≥80	Ra≥80
色溫 Color.t	3000~6000K	3000~6000K	3000~6000K	3000~6000K
外殼材質 Case Material	鋁材 Aluminum	鋁材 Aluminum	鋁材 Aluminum	鋁材 Aluminum
發光顏色 Emitting color	白光 /W 暖白 /WW	白光 /W 暖白 /WW	白光 /W 暖白 /WW	白光 /W 暖白 /WW

# LED BULB LIGHT

LED 燈泡



DL-13141  
Ø120mm H230mm



DL-13142  
Ø120mm H195mm



DL-13143  
Ø95mm H213mm



DL-13144  
Ø96mm H183.5mm

產品型號 Model	DL-13141	DL-13142	DL-13143	DL-13144
燈具功率 LED power	15W	20W	30W	40W
輸入電壓 Input Voltage	AC100~240V	AC100~240V	AC100~240V	AC100~240V
顯色指數 Color Rendering Index	Ra≥80	Ra≥80	Ra≥80	Ra≥80
色溫 Color.t	3000~6000K	3000~6000K	3000~6000K	3000~6000K
外殼材質 Case Material	鋁材 Aluminum	鋁材 Aluminum	鋁材 Aluminum	鋁材 Aluminum
發光顏色 Emitting color	白光 / 暖白	白光 / 暖白	白光 / 暖白	白光 / 暖白

# LED CANDLE BULB LIGHT

LED 蠟燭燈泡



DL-13151



DL-13152



DL-13153



DL-13154



DL-13155



DL-13156

產品型號 Model	DL-13151	DL-13152	DL-13153	DL-13154	DL-13155	DL-13156
燈具功率 LED power	4W	4W	4W	5W	5W	3W
輸入電壓 Input Voltage	AC100~240V	AC100~240V	AC100~240V	AC100~240V	AC100~240V	AC100~240V
顯色指數 Color Rendering Index	Ra≥80	Ra≥80	Ra≥80	Ra≥80	Ra≥80	Ra≥80
色溫 Color.t	3000~6000K	3000~6000K	3000~6000K	3000~6000K	3000~6000K	3000~6000K
外殼材質 Case Material	鋁材 Aluminum	鋁材 Aluminum	鋁材 Aluminum	鋁材 Aluminum	鋁材 Aluminum	鋁材 Aluminum
發光顏色 Emitting color	白光 / 暖白	白光 / 暖白	白光 / 暖白	白光 / 暖白	白光 / 暖白	白光 / 暖白



# LED E27 LIGHT CUP

LED E27 燈杯



DL-13161  
Ø50mm H70mm

## ◆ 產品特點

採用臺灣大晶片安全可靠  
AC 定電流專用電源  
無熱輻射、紫外線、永保產品亮麗、不褪色  
鋁合金散熱片外殼，散熱效果極佳，壽命長  
採用平面光學透鏡、使光綫更柔和  
LED 取代傳統鹵素燈具，壽命是傳統的 8 倍  
適合空間：精品展示、畫廊、珠寶櫥櫃、飯店、餐廳、情境照明、居家重點照明等

## ◆ Product characteristics

Adopting Taiwan Epistar Chip, more reliable  
AC constant current power supply  
No thermal radiation, no UV, Keep bright color for ever  
Aluminum alloy heat sink shell, superior effects, long lifespan  
Plane optical lens reflects softer rays of light  
LED replaces traditional halogen lamps, the lifespan is 8 times of the latter  
Application: Boutique showcase, art gallery, jewelry cabinet, restaurant and dining room, situation lighting, home accent lighting, etc..



DL-13162  
Ø563mm H90mm

產品型號 Model	DL-13161	DL-13162
燈具功率 LED power	6W	PAR20 6W
輸入電壓 Input Voltage	AC100~240V / 50~60Hz	AC100~240V / 50~60Hz
顯色指數 Color Rendering Index	Ra≥80	Ra≥80
色溫 Color.t	3000~6000K	3000~6000K
外殼材質 Case Material	鋁材 Aluminum	鋁材 Aluminum
發光顏色 Emitting color	白光 /W 暖白 /WW	白光 /W 暖白 /WW

# LED PAR BULB

可調光 LED PAR 燈泡



DL-13171



DL-13172



DL-13173

產品型號 Model	DL-1317	DL-13172	DL-13173
燈具功率 LED power	R50 5W	R63 8W	R80 12W
輸入電壓 Input Voltage	AC100~240V	AC100~240V	AC100~240V
顯色指數 Color Rendering Index	Ra≥80	Ra≥63	Ra≥80
色溫 Color.t	3000~6000K	3000~6000K	3000~6000K
外殼材質 Case Material	鋁材 Aluminum	鋁材 Aluminum	鋁材 Aluminum
發光顏色 Emitting color	白光 /W 暖白 /WW	白光 /W 暖白 /WW	白光 /W 暖白 /WW

# LED PAR BULB

LED PAR 燈泡



DL-13181

DL-13182



DL-13183

DL-13184

產品型號 Model	DL-13181	DL-13182	DL-13183	DL-13184
燈具功率 LED power	PAR30 14W	PAR 38 24W	PAR30 7W	PAR 38 12W
輸入電壓 Input Voltage	AC100~240V	AC100~240V	AC100~240V	AC100~240V
顯色指數 Color Rendering Index	Ra≥80	Ra≥80	Ra≥80	Ra≥80
色溫 Color.t	3000~6000K	3000~6000K	3000~6000K	3000~6000K
外殼材質 Case Material	鋁材 Aluminum	鋁材 Aluminum	鋁材 Aluminum	鋁材 Aluminum
發光顏色 Emitting color	白光 /W 暖白 /WW	白光 /W 暖白 /WW	白光 /W 暖白 /WW	白光 /W 暖白 /WW

# LED BULB

LED 燈泡



DL-13191

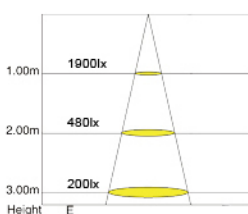

DL-13192

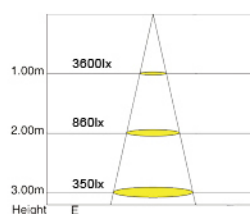

DL-13193

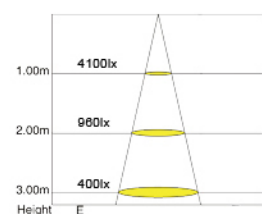

產品型號 Model	DL-13191	DL-13192	DL-13193
燈具功率 LED power	PAR30 10W	PAR38 12W	PAR 38 15W
輸入電壓 Input Voltage	AC100~240V	AC100~240V	AC100~240V
顯色指數 Color Rendering Index	Ra≥80	Ra≥80	Ra≥80
色溫 Color.t	3000~6000K	3000~6000K	3000~6000K
外殼材質 Case Material	鋁材 Aluminum	鋁材 Aluminum	鋁材 Aluminum
發光顏色 Emitting color	白光 /W 暖白 /WW	白光 /W 暖白 /WW	白光 /W 暖白 /WW

# LED BULB

LED 燈泡



DL-13201  
Ø36mm L110mm



DL-13202  
Ø80mm L230mm



DL-13203  
Ø103mm L270mm

產品型號 Model	DL-13201	DL-13202	DL-13203
燈具功率 LED power	7W	18W	32W
輸入電壓 Input Voltage	AC100~240V	AC100~240V	AC100~240V
顯色指數 Color Rendering Index	Ra≥80	Ra≥80	Ra≥80
色溫 Color.t	3000~6000K	3000~6000K	3000~6000K
外殼材質 Case Material	鋁材 Aluminum	鋁材 Aluminum	鋁材 Aluminum
發光顏色 Emitting color	白光 /W 暖白 /WW	白光 /W 暖白 /WW	白光 /W 暖白 /WW

# LED AR111

LED AR111



DL-13211



DL-13212

## ◆ 產品特點

採用臺灣大晶片安全可靠

AC 定電流專用電源

無熱輻射、紫外線、永保產品亮麗、不褪色

鋁合金散熱片外殼，散熱效果極佳，壽命長

採用平面光學透鏡，使光線更柔和

LED 取代傳統鹵素燈具，壽命是傳統的 8 倍

適合空間：精品展示、畫廊、珠寶櫥櫃、飯店、餐廳、情境照明、居家重點照明等

產品型號 Model	DL-13211	DL-13212
燈具功率 LED power	10W	14W
輸入電壓 Input Voltage	AC100~240V	AC100~240V
顯色指數 Color Rendering Index	Ra≥80	Ra≥80
色溫 Color.t	3000~6000K	3000~6000K
外殼材質 Case Material	鋁材 Aluminum	鋁材 Aluminum
發光顏色 Emitting color	白光 /W 暖白 /WW	白光 /W 暖白 /WW

# LED DOWNLIGHT

LED 嵌燈



DL-13221

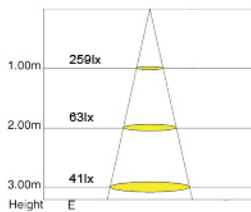
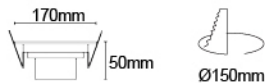

DL-13222

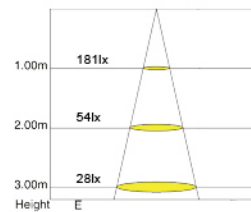

產品型號 Model	DL-13221	DL-13222
燈具功率 LED power	10W	12W
輸入電壓 Input Voltage	AC100~240V	AC100~240V
顯色指數 Color Rendering Index	Ra≥80	Ra≥80
色溫 Color.t	3000~6000K	3000~6000K
外殼材質 Case Material	鋁材 Aluminum	鋁材 Aluminum
發光顏色 Emitting color	白光 /W 暖白 /WW	白光 /W 暖白 /WW



# LED DOWNLIGHT

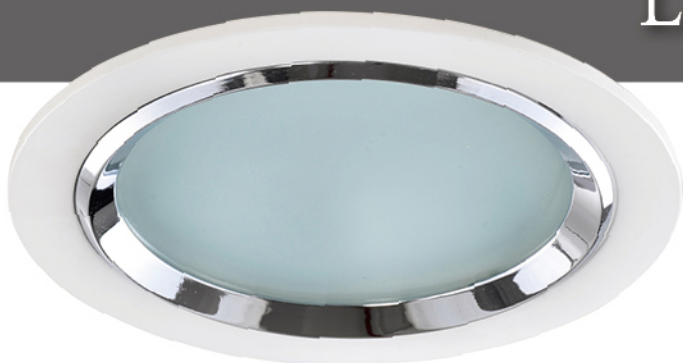

DL-13231 Ø120mm H45mm  
↳ Ø100mm

DL-13232 Ø150mm H45mm  
↳ Ø125mm

DL-13233 Ø180mm H60mm  
↳ Ø160mm

DL-13234 Ø228mm H60mm  
↳ Ø205mm

產品型號 Model	DL-13231	DL-13232	DL-13233	DL-13234
燈具功率 LED power	8W	12W	15W	20W
輸入電壓 Input Voltage	AC100~240V	AC100~240V	AC100~240V	AC100~240V
顯色指數 Color Rendering Index	Ra≥80	Ra≥80	Ra≥80	Ra≥80
色溫 Color.t	3000~6000K	3000~6000K	3000~6000K	3000~6000K
外殼材質 Case Material	鋁材 Aluminum	鋁材 Aluminum	鋁材 Aluminum	鋁材 Aluminum
發光顏色 Emitting color	白光 /W 暖白 /WW	白光 /W 暖白 /WW	白光 /W 暖白 /WW	白光 /W 暖白 /WW



# LED DOWNLIGHT

LED 嵌燈



DL-13241 Ø120mm H45mm  
↳ Ø100mm

DL-13242 Ø150mm H45mm  
↳ Ø125mm

DL-13243 Ø180mm H60mm  
↳ Ø160mm

DL-13244 Ø228mm H60mm  
↳ Ø205mm

產品型號	功率 (w)	亮度 (Lm)	色溫	材質	輸入電壓	芯片	工作壽命	功率因數
DL-13241	8	480	3000K 6000K	PC + Aluminium	AC100~240V DC24V	LRU	30,000Hr	>90%
DL-13242	12	800	3000K 6000K	PC + Aluminium	AC100~240V DC24V	LRU	30,000Hr	>90%
DL-13243	15	950	3000K 6000K	PC + Aluminium	AC100~240V DC24V	LRU	30,000Hr	>90%
DL-13244	20	1380	3000K 6000K	PC + Aluminium	AC100~240V DC24V	LRU	30,000Hr	>90%

# LED DOWNLIGHT



**DL-13251**  
 Ø930mm H45mm  
 ↙ ↘ Ø83mm

**DL-13252**  
 Ø130mm H50mm  
 ↙ ↘ Ø115mm

**DL-13253**  
 Ø160mm H50mm  
 ↙ ↘ Ø140mm

產品型號	功率 (w)	亮度 (Lm)	色溫	材質	輸入電壓	芯片	工作壽命	功率因數
<b>DL-13251</b>	4	360	3000K 6000K	PC + Aluminium	AC100~240V DC24V	LRU	30,000Hr	>90%
<b>DL-13252</b>	8	480	3000K 6000K	PC + Aluminium	AC100~240V DC24V	LRU	30,000Hr	>90%
<b>DL-13253</b>	12	800	3000K 6000K	PC + Aluminium	AC100~240V DC24V	LRU	30,000Hr	>90%

# LED DOWNLIGHT

LED 嵌燈



KH-13261

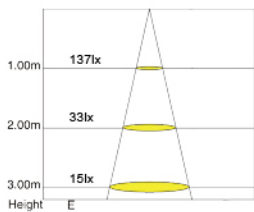
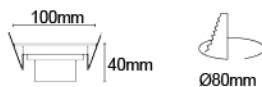

KH-13262

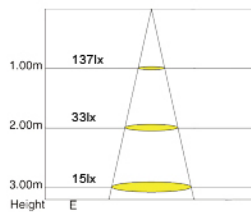
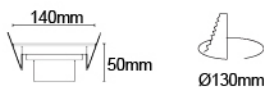

KH-13263

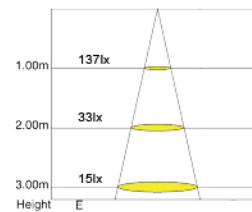
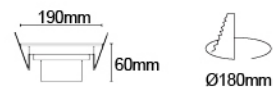

產品型號 Model	KH-13261	KH-13262	KH-13263
燈具功率 LED power	8W	15W	25W
輸入電壓 Input Voltage	AC100~240V / 50~60Hz	AC100~240V / 50~60Hz	AC100~240V / 50~60Hz
顯色指數 Color Rendering Index	Ra≥80	Ra≥80	Ra≥80
色溫 Color.t	3000~6000K	3000~6000K	3000~6000K
外殼材質 Case Material	鋁材 Aluminum	鋁材 Aluminum	鋁材 Aluminum
發光顏色 Emitting color	白光 /W 暖白 /WW	白光 /W 暖白 /WW	白光 /W 暖白 /WW

# LED DOWNLIGHT

LED 嵌燈



KH-13271

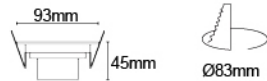

KH-13272



KH-13273

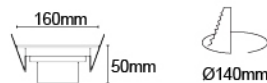

KH-13274



## 產品特點

- 採用臺灣大晶片安全可靠
- AC 定電流專用電源
- 無熱輻射、紫外線、永保產品亮麗、不褪色
- 鋁合金散熱片外殼，散熱效果極佳，壽命長
- 採用平面光學透鏡、使光線更柔和
- LED 取代傳統鹵素燈具，壽命是傳統的 8 倍
- 適合空間：精品展示、畫廊、珠寶櫥櫃、飯店、餐廳、情境照明、居家重點照明等

## Product characteristics

- Adopting Taiwan Epistar Chip, more reliable
- AC constant current power supply
- No thermal radiation, no UV, Keep bright color for ever
- Aluminum alloy heat sink shell, superior effects, long lifespan
- Plane optical lens reflects softer rays of light
- LED replaces traditional halogen lamps, the lifespan is 8 times of the latter
- Application: Boutique showcase, art gallery, jewelry cabinet, restaurant and dining room, situation lighting, home accent lighting, etc..

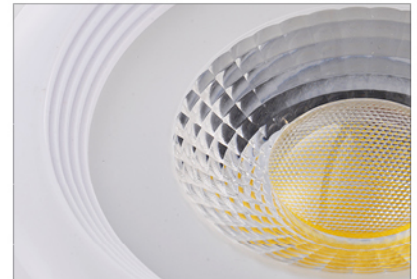

產品型號 Model	KH-13271	KH-13272	KH-13273	KH-13274
燈具功率 LED power	8W	12W	15W	25W
輸入電壓 Input Voltage	AC100~240V 50~60Hz	AC100~240V 50~60Hz	AC100~240V 50~60Hz	AC100~240V 50~60Hz
顯色指數 Color Rendering Index	Ra≥80	Ra≥80	Ra≥80	Ra≥80
色溫 Color.t	3000~6000K	3000~6000K	3000~6000K	3000~6000K
外殼材質 Case Material	鋁材 Aluminum	鋁材 Aluminum	鋁材 Aluminum	鋁材 Aluminum
發光顏色 Emitting color	白光 /W 暖白 /WW	白光 /W 暖白 /WW	白光 /W 暖白 /WW	白光 /W 暖白 /WW

# LED CAST SPOT LIGHT

LED 投射燈

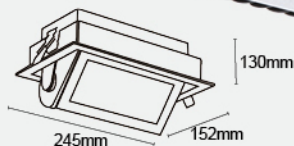

## ◆ 產品特點

採用臺灣大晶片安全可靠

AC 定電流專用電源

無熱輻射、紫外線、永保產品亮麗、不褪色

鋁合金散熱片外殼，散熱效果極佳，壽命長

採用平面光學透鏡、使光線更柔和

LED 取代傳統鹵素燈具，壽命是傳統的 8 倍

適合空間：精品展示、畫廊、珠寶櫥櫃、飯店、餐廳、情境照明、居家重點照明等

## ◆ Product characteristics

Adopting Taiwan Epistar Chip, more reliable

AC constant current power supply

No thermal radiation, no UV, Keep bright color for ever

Aluminum alloy heat sink shell, superior effects, long lifespan

Plane optical lens reflects softer rays of light

LED replaces halogen lamps, the lifespan is 8 times of the latter

Application: Boutique showcase, art gallery, jewelry cabinet, restaurant and dining room, situation lighting, home accent lighting, etc..

產品型號 Model	DL-13281	DL-13282	DL-13283
燈具功率 LED power	20W	28W	38W
輸入電壓 Input Voltage	AC100~240V / 50~60Hz	AC100~240V / 50~60Hz	AC100~240V / 50~60Hz
顯色指數 Color Rendering Index	Ra≥80	Ra≥80	Ra≥80
色溫 Color.t	3000~6000K	3000~6000K	3000~6000K
外殼材質 Case Material	鋁材 Aluminum	鋁材 Aluminum	鋁材 Aluminum
發光顏色 Emitting color	白光 /W 暖白 /WW	白光 /W 暖白 /WW	白光 /W 暖白 /WW

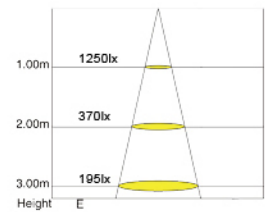
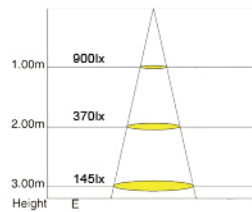
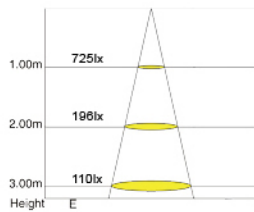
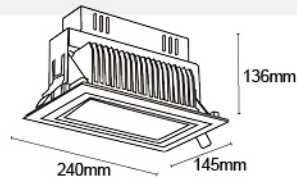
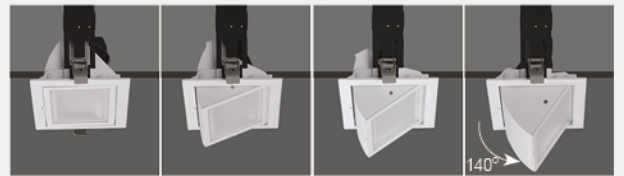

產品型號 Model	DL-13291	DL-13292	DL-13293
燈具功率 LED power	20W	28W	38W
輸入電壓 Input Voltage	AC100~240V / 50~60Hz	AC100~240V / 50~60Hz	AC100~240V / 50~60Hz
顯色指數 Color Rendering Index	Ra≥80	Ra≥80	Ra≥80
色溫 Color.t	3000~6000K	3000~6000K	3000~6000K
外殼材質 Case Material	鋁材 Aluminum	鋁材 Aluminum	鋁材 Aluminum
發光顏色 Emitting color	白光 /W 暖白 /WW	白光 /W 暖白 /WW	白光 /W 暖白 /WW

# LED MR16 DOWN LIGHT

LED MR16 嵌燈

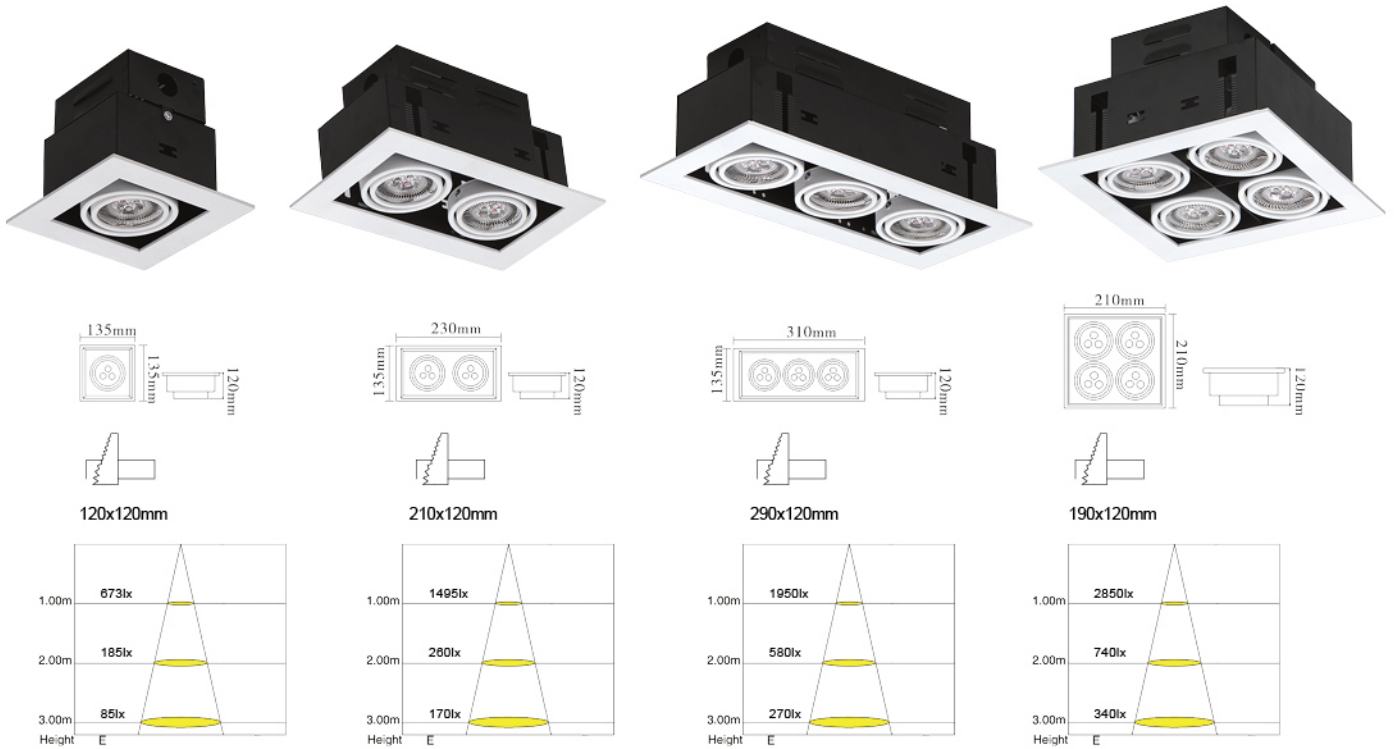

產品型號 Model	DL-13301	DL-13302	DL-13303	DL-13304
燈具功率 LED power	6W	12W	18W	24W
輸入電壓 Input Voltage	AC100~240V 50~60Hz	AC100~240V 50~60Hz	AC100~240V 50~60Hz	AC100~240V 50~60Hz
顯色指數 Color Rendering Index	Ra≥80	Ra≥80	Ra≥80	Ra≥80
色溫 Color.t	3000~6000K	3000~6000K	3000~6000K	3000~6000K
外殼材質 Case Material	鋁材 Aluminum	鋁材 Aluminum	鋁材 Aluminum	鋁材 Aluminum
發光顏色 Emitting color	白光 /W 暖白 /WW	白光 /W 暖白 /WW	白光 /W 暖白 /WW	白光 /W 暖白 /WW

# LED MR16 DOWN LIGHT

LED MR16 嵌燈

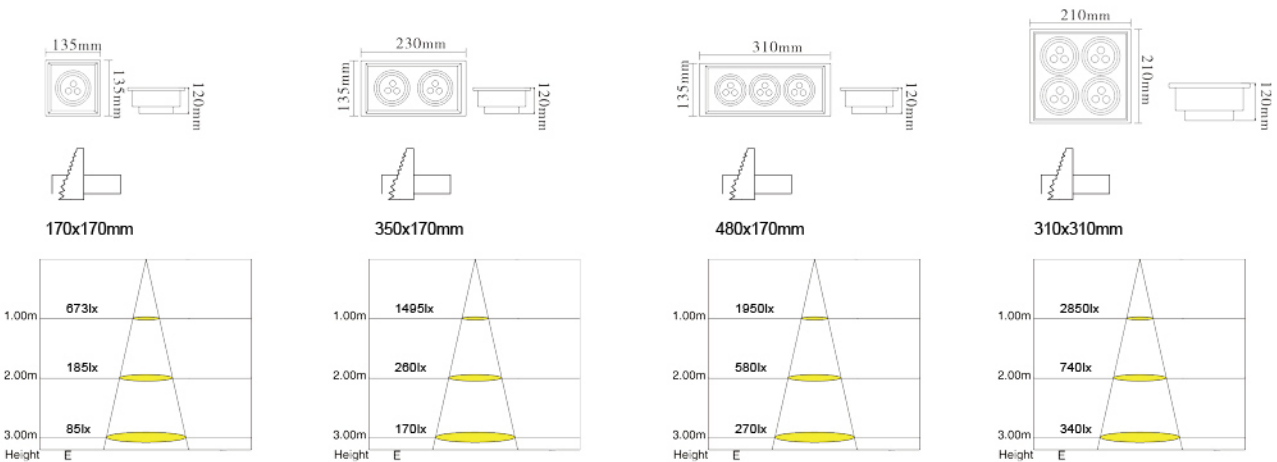

產品型號 Model	DL-13311	DL-13312	DL-13313	DL-13314
燈具功率 LED power	10W	20W	30W	40W
輸入電壓 Input Voltage	AC100~240V 50~60Hz	AC100~240V 50~60Hz	AC100~240V 50~60Hz	AC100~240V 50~60Hz
顯色指數 Color Rendering Index	Ra≥80	Ra≥80	Ra≥80	Ra≥80
色溫 Color.t	3000~6000K	3000~6000K	3000~6000K	3000~6000K
外殼材質 Case Material	鋁材 Aluminum	鋁材 Aluminum	鋁材 Aluminum	鋁材 Aluminum
發光顏色 Emitting color	白光 /W 暖白 /WW	白光 /W 暖白 /WW	白光 /W 暖白 /WW	白光 /W 暖白 /WW





 **DL-13321**  
440x150mm L446mm W156mm H108mm



 **DL-13322**  
300x150mm L301mm W156mm H108mm



 **DL-13323**  
150x150mm L166mm W156mm H108mm

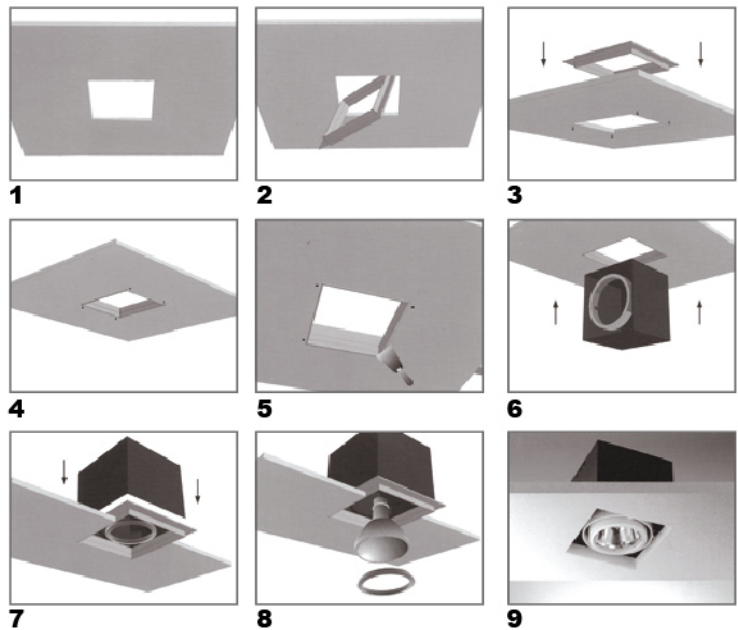

產品型號 Model	DL-13321	DL-13322	DL-13323
燈具功率 LED power	10W x 3	10W x 2	10W x 1
輸入電壓 Input Voltage	AC100~240V 50~60Hz	AC100~240V 50~60Hz	AC100~240V 50~60Hz
顯色指數 Color Rendering Index	Ra≥80	Ra≥80	Ra≥80
色溫 Color.t	3000~6000K	3000~6000K	3000~6000K
外殼材質 Case Material	鋁材 Aluminum	鋁材 Aluminum	鋁材 Aluminum
發光顏色 Emitting color	白光 /W 暖白 /WW	白光 /W 暖白 /WW	白光 /W 暖白 /WW

# LED AR111 DOWN LIGHT



DL-13331

440x150mm L440mm W150mm H85mm



DL-13332

300x150mm L300mm W150mm H85mm



DL-13333

150x150mm L150mm W150mm H85mm

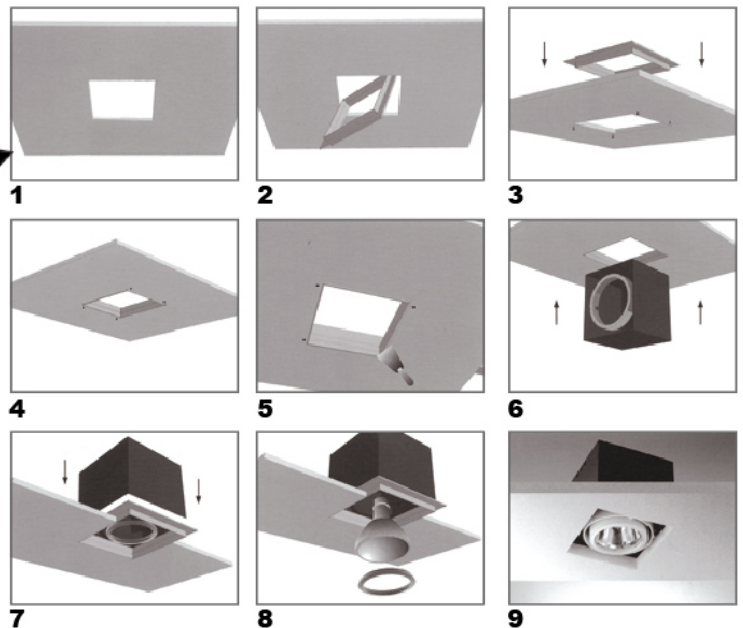

產品型號 Model	DL-13331	DL-13332	DL-13333
燈具功率 LED power	10W x 3	10W x 2	10W x 1
輸入電壓 Input Voltage	AC100~240V 50~60Hz	AC100~240V 50~60Hz	AC100~240V 50~60Hz
顯色指數 Color Rendering Index	Ra≥80	Ra≥80	Ra≥80
色溫 Color.t	3000~6000K	3000~6000K	3000~6000K
外殼材質 Case Material	鋁材 Aluminum	鋁材 Aluminum	鋁材 Aluminum
發光顏色 Emitting color	白光 /W 暖白 /WW	白光 /W 暖白 /WW	白光 /W 暖白 /WW

# LED DOWNLIGHT

LED 嵌燈



DL-13341



DL-13342



DL-13343

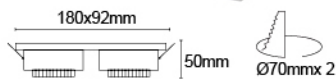

DL-13344

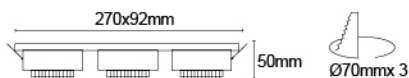

產品型號 Model	DL-13341	DL-13342	DL-13343	DL-13344
燈具功率 LED power	3W	3W	6W	9W
輸入電壓 Input Voltage	AC100~240V 50~60Hz	AC100~240V 50~60Hz	AC100~240V 50~60Hz	AC100~240V 50~60Hz
顯色指數 Color Rendering Index	Ra≥80	Ra≥80	Ra≥80	Ra≥80
色溫 Color.t	3000~6000K	3000~6000K	3000~6000K	3000~6000K
外殼材質 Case Material	鋁材 Aluminum	鋁材 Aluminum	鋁材 Aluminum	鋁材 Aluminum
發光顏色 Emitting color	白光 /W 暖白 /WW	白光 /W 暖白 /WW	白光 /W 暖白 /WW	白光 /W 暖白 /WW

# LED DOWNLIGHT

LED 嵌燈



DL-13351

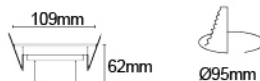

DL-13352

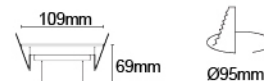

DL-13353

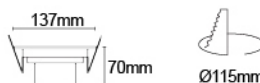

DL-13354

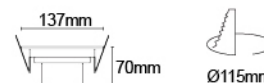

產品型號 Model	DL-13351	DL-13352	DL-13353	DL-13354
燈具功率 LED power	5W	7W	9W	12W
輸入電壓 Input Voltage	AC100~240V 50~60Hz	AC100~240V 50~60Hz	AC100~240V 50~60Hz	AC100~240V 50~60Hz
顯色指數 Color Rendering Index	Ra≥80	Ra≥80	Ra≥80	Ra≥80
色溫 Color.t	3000~6000K	3000~6000K	3000~6000K	3000~6000K
外殼材質 Case Material	鋁材 Aluminum	鋁材 Aluminum	鋁材 Aluminum	鋁材 Aluminum
發光顏色 Emitting color	白光 /W 暖白 /WW	白光 /W 暖白 /WW	白光 /W 暖白 /WW	白光 /W 暖白 /WW

# LED TRACK LIGHT

LED 軌道燈



DL-13361



DL-13362



DL-13363



DL-13364

## ◆ 產品特點

採用臺灣大晶片安全可靠

AC 定電流專用電源

無熱輻射、紫外線、永保產品亮麗、不褪色

鋁合金散熱片外殼，散熱效果極佳，壽命長

採用平面光學透鏡，使光線更柔和

LED 取代傳統鹵素燈具，壽命是傳統的 8 倍

適合空間：精品展示、畫廊、珠寶櫥櫃、飯店、餐廳、情境照明、居家重點照明等

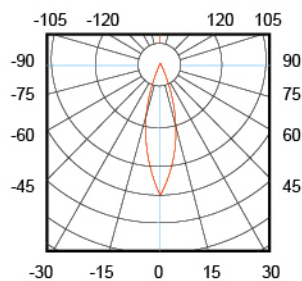

產品型號 Model	DL-13361	DL-13362	DL-13363	DL-13364
燈具功率 LED power	10W	10W	14W	14W
輸入電壓 Input Voltage	AC100~240V 50~60Hz	AC100~240V 50~60Hz	AC100~240V 50~60Hz	AC100~240V 50~60Hz
顯色指數 Color Rendering Index	Ra≥80	Ra≥80	Ra≥80	Ra≥80
色溫 Color.t	3000~6000K	3000~6000K	3000~6000K	3000~6000K
外殼材質 Case Material	鋁材 Aluminum	鋁材 Aluminum	鋁材 Aluminum	鋁材 Aluminum
發光顏色 Emitting color	白光 /W 暖白 /WW	白光 /W 暖白 /WW	白光 /W 暖白 /WW	白光 /W 暖白 /WW



DL-13371



DL-13372



DL-13373



DL-13374

◆Product characteristics

Adopting Taiwan Epistar Chip, more reliable  
 AC constant current power supply  
 No thermal radiation, no UV, Keep bright color for ever  
 Aluminum alloy heat sink shell, superior effects, long lifespan  
 Plane optical lens reflects softer rays of light  
 LED cakes plane of traditional halogen lamps, the lifespan is 8 times of the latter  
 Application: Boutique showcase, art gallery, jewelry cabinet, restaurant and dining room, situation lighting, home accent lighting, etc..

產品型號 Model	DL-13371	DL-13372	DL-13373	DL-13374
燈具功率 LED power	5W	5W	5W	5W
輸入電壓 Input Voltage	AC100~240V 50~60Hz	AC100~240V 50~60Hz	AC100~240V 50~60Hz	AC100~240V 50~60Hz
顯色指數 Color Rendering Index	Ra≥80	Ra≥80	Ra≥80	Ra≥80
色溫 Color.t	3000~6000K	3000~6000K	3000~6000K	3000~6000K
外殼材質 Case Material	鋁材 Aluminum	鋁材 Aluminum	鋁材 Aluminum	鋁材 Aluminum
發光顏色 Emitting color	白光 /W 暖白 /WW	白光 /W 暖白 /WW	白光 /W 暖白 /WW	白光 /W 暖白 /WW

# LED TARCK LIGHT

LED 軌道燈



DL-13381



DL-13382



DL-13383



DL-13384

產品型號 Model	DL-13381	DL-13382	DL-13383	DL-13384
燈具功率 LED power	7W	PAR30 7W	12W	12W
輸入電壓 Input Voltage	AC100~240V	AC100~240V	AC100~240V	AC100~240V
顯色指數 Color Rendering Index	Ra≥80	Ra≥80	Ra≥80	Ra≥80
色溫 Color.t	2700~5000K	2700~5000K	2700~5000K	2700~5000K
外殼材質 Case Material	鋁材 Aluminum	鋁材 Aluminum	鋁材 Aluminum	鋁材 Aluminum
發光顏色 Emitting color	白光 /W 暖白 /WW	白光 /W 暖白 /WW	白光 /W 暖白 /WW	白光 /W 暖白 /WW

# LED TARCK LIGHT

LED 軌道燈



DL-13391

DL-13392

DL-13393

## ◆ 產品特點

採用臺灣大晶片安全可靠

AC 定電流專用電源

無熱輻射、紫外線、永保產品亮麗、不褪色

鋁合金散熱片外殼，散熱效果極佳，壽命長

採用平面光學透鏡、使光線更柔和

LED 取代傳統鹵素燈具，壽命是傳統的 8 倍

適合空間：精品展示、畫廊、珠寶櫥櫃、飯店、餐廳、情境照明、居家重點照明等

## ◆ Product characteristics

Adopting Taiwan Epistar Chip, more reliable

AC constant current power supply

No thermal radiation, no UV, Keep bright color for ever

Aluminum alloy heat sink shell, superior effects, long lifespan

Plane optical lens reflects softer rays of light

LED takes place of traditional halogen lamps, the lifespan is 8 times of the latter

Application: Boutique showcase, art gallery, jewelry cabinet, restaurant and dining room, situation lighting, home accent lighting, etc..



產品型號 Model	DL-13391	DL-13392	DL-13393
燈具功率 LED power	4W	10W	14W
輸入電壓 Input Voltage	AC100~240V	AC100~240V	AC100~240V
顯色指數 Color Rendering Index	Ra≥80	Ra≥80	Ra≥80
色溫 Color.t	2700~5000K	2700~5000K	2700~5000K
外殼材質 Case Material	鋁材 Aluminum	鋁材 Aluminum	鋁材 Aluminum
發光顏色 Emitting color	白光 /W 暖白 /WW	白光 /W 暖白 /WW	白光 /W 暖白 /WW



# LED TARCK LIGHT

LED 軌道燈

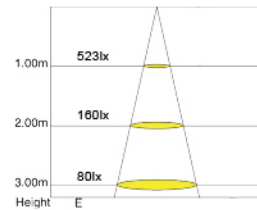
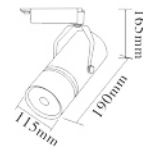
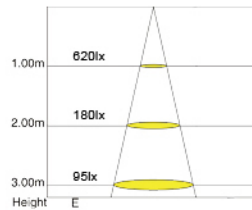
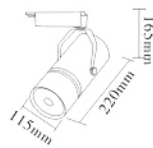
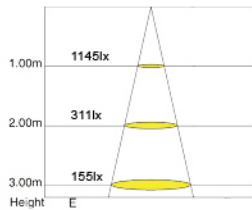

產品型號 Model	DL-13401	DL-13402	DL-13403
燈具功率 LED power	50W	30W	20W
輸入電壓 Input Voltage	AC100~240V / 50~60Hz	AC100~240V / 50~60Hz	AC100~240V / 50~60Hz
顯色指數 Color Rendering Index	Ra≥80	Ra≥80	Ra≥80
色溫 Color.t	3000~6000K	3000~6000K	3000~6000K
外殼材質 Case Material	鋁材 Aluminum	鋁材 Aluminum	鋁材 Aluminum
發光顏色 Emitting color	白光 /W 暖白 /WW	白光 /W 暖白 /WW	白光 /W 暖白 /WW

# LED TARCK LIGHT

LED 軌道燈

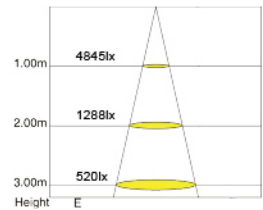
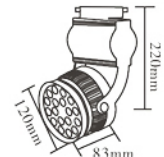
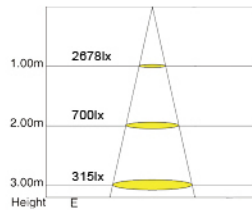
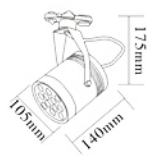
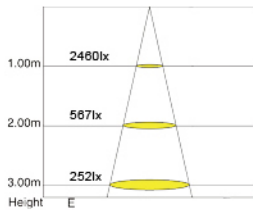
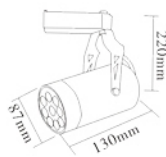

產品型號 Model	DL-13411	DL-13412	DL-13413
燈具功率 LED power	12W	15W	21W
輸入電壓 Input Voltage	AC100~240V / 50~60Hz	AC100~240V / 50~60Hz	AC100~240V / 50~60Hz
顯色指數 Color Rendering Index	Ra≥80	Ra≥80	Ra≥80
色溫 Color.t	3000~6000K	3000~6000K	3000~6000K
外殼材質 Case Material	鋁材 Aluminum	鋁材 Aluminum	鋁材 Aluminum
發光顏色 Emitting color	白光 /W 暖白 /WW	白光 /W 暖白 /WW	白光 /W 暖白 /WW

# LED TARCK LIGHT

LED 軌道燈

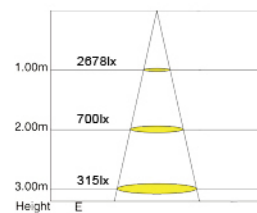
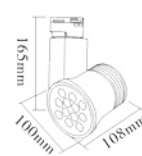
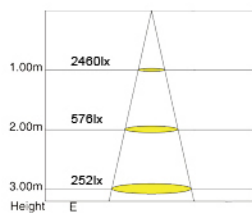
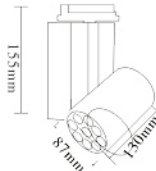
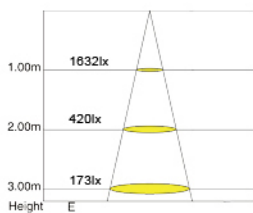
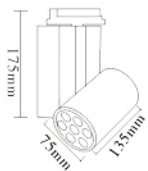

產品型號 Model	DL-13421	DL-13422	DL-13423
燈具功率 LED power	10W	12W	15W
輸入電壓 Input Voltage	AC100~240V / 50~60Hz	AC100~240V / 50~60Hz	AC100~240V / 50~60Hz
顯色指數 Color Rendering Index	Ra≥80	Ra≥80	Ra≥80
色溫 Color.t	3000~6000K	3000~6000K	3000~6000K
外殼材質 Case Material	鋁材 Aluminum	鋁材 Aluminum	鋁材 Aluminum
發光顏色 Emitting color	白光 /W 暖白 /WW	白光 /W 暖白 /WW	白光 /W 暖白 /WW

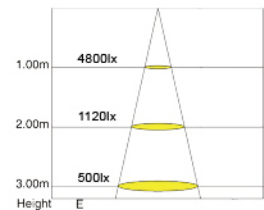
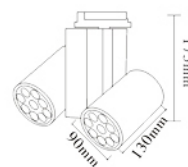
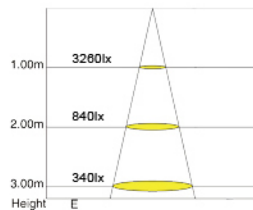
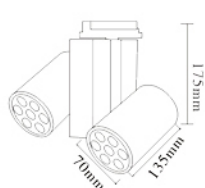

#### Product characteristics

Adopting Taiwan Epistar Chip, more reliable  
 AC constant current power supply  
 No thermal radiation, no UV, Keep bright color for ever  
 Aluminum alloy heat sink shell, superior effects, long lifespan  
 Plane optical lens reflects softer rays of light  
 LED candles replace of traditional halogen lamps, the lifespan is 8 times of the latter  
 Application: Boutique showcase, art gallery, jewelry cabinet, restaurant and dining room, situation lighting, home accent lighting, etc..

產品型號 Model	DL-13431	DL-13432
燈具功率 LED power	20W	24W
輸入電壓 Input Voltage	AC100~240V / 50~60Hz	AC100~240V / 50~60Hz
顯色指數 Color Rendering Index	Ra≥80	Ra≥80
色溫 Color.t	3000~6000K	3000~6000K
外殼材質 Case Material	鋁材 Aluminum	鋁材 Aluminum
發光顏色 Emitting color	白光 /W 暖白 /WW	白光 /W 暖白 /WW

# LED DOWN LIGHT

LED 筒燈

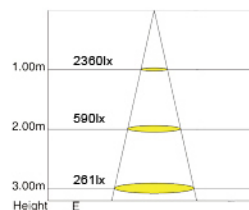
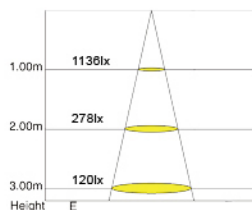
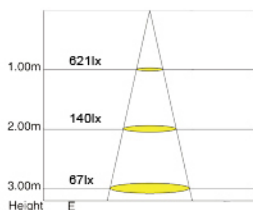

## 產品特點

採用臺灣大晶片安全可靠

AC 定電流專用電源

無熱輻射、紫外線、永保產品亮麗、不褪色

鋁合金散熱片外殼，散熱效果極佳，壽命長

採用平面光學透鏡，使光線更柔和

LED 取代傳統鹵素燈具，壽命是傳統的 8 倍

適合空間：精品展示、畫廊、珠寶櫥櫃、飯店、餐廳、情境照明、居家重點照明等

產品型號 Model	DL-13441	DL-13442	DL-13443
燈具功率 LED power	6W	8W	15W
輸入電壓 Input Voltage	AC100~240V / 50~60Hz	AC100~240V / 50~60Hz	AC100~240V / 50~60Hz
顯色指數 Color Rendering Index	Ra≥80	Ra≥80	Ra≥80
色溫 Color.t	3000~6000K	3000~6000K	3000~6000K
外殼材質 Case Material	鋁材 Aluminum	鋁材 Aluminum	鋁材 Aluminum
發光顏色 Emitting color	白光 /W 暖白 /WW	白光 /W 暖白 /WW	白光 /W 暖白 /WW

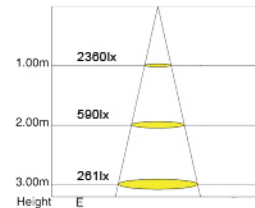
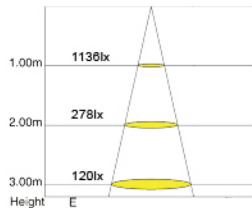
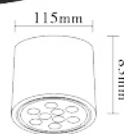
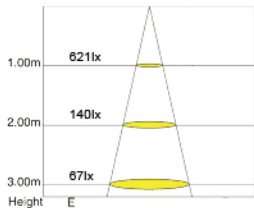
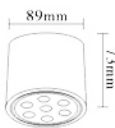

### Product characteristics

- Adopting Taiwan Epistar Chip, more reliable
- AC constant current power supply
- No thermal radiation, no UV, Keep bright color for ever
- Aluminum alloy heat sink shell, superior effects, long lifespan
- Plane optical lens reflects softer rays of light
- LED light is more energy saving than traditional halogen lamps, the lifespan is 8 times of the latter
- Application: Boutique showcase, art gallery, jewelry cabinet, restaurant and dining room, situation lighting, home accent lighting, etc..

產品型號 Model	DL-13451	DL-13452	DL-13453
燈具功率 LED power	10W	12W	15W
輸入電壓 Input Voltage	AC100~240V / 50~60Hz	AC100~240V / 50~60Hz	AC100~240V / 50~60Hz
顯色指數 Color Rendering Index	Ra≥80	Ra≥80	Ra≥80
色溫 Color.t	3000~6000K	3000~6000K	3000~6000K
外殼材質 Case Material	鋁材 Aluminum	鋁材 Aluminum	鋁材 Aluminum
發光顏色 Emitting color	白光 /W 暖白 /WW	白光 /W 暖白 /WW	白光 /W 暖白 /WW

# LED CEILING

LED 吸頂燈



**DL-13461**  
SIZE:L345mm W115mm H75mm



**DL-13462**  
SIZE:L320mm W320mm

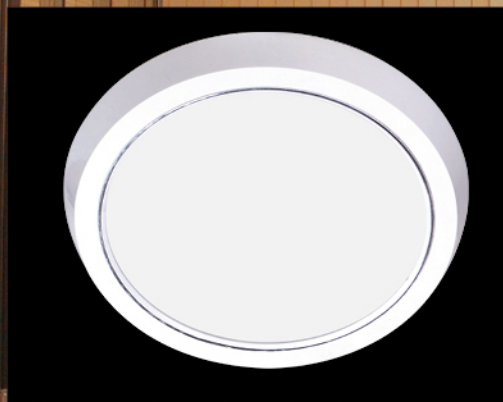

**DL-13463**  
SIZE:Ø300mm



**DL-13464**  
SIZE:L300mm W300mm H20mm



**DL-13465**  
SIZE:L300mm W600mm H20mm



**DL-13466**  
SIZE:L600mm W600mm H20mm

## ◆ 產品特點

採用臺灣大晶片安全可靠

AC 定電流專用電源

無熱輻射、紫外線、永保產品亮麗、不褪色

鋁合金散熱片外殼，散熱效果極佳，壽命長

採用平面光學透鏡、使光線更柔和

LED 取代傳統鹵素燈具，壽命是傳統的 8 倍

適合空間：精品展示、畫廊、珠寶櫥櫃、飯店、餐廳、情境照明、居家重點照明等

產品型號 Model	DL-13461	DL-13462	DL-13463	DL-13464
燈具功率 LED power	9W	14W	12W	12W
輸入電壓 Input Voltage	AC100~240V	AC100~240V	AC100~240V	AC100~240V
顯色指數 Color Rendering Index	Ra≥80	Ra≥80	Ra≥80	Ra≥80
色溫 Color.t	2700~5000K	2700~5000K	2700~5000K	2700~5000K
外殼材質 Case Material	鋁材 Aluminum	鋁材 Aluminum	鋁材 Aluminum	鋁材 Aluminum
發光顏色 Emitting color	白光 /W 暖白 /WW	白光 /W 暖白 /WW	白光 /W 暖白 /WW	白光 /W 暖白 /WW

# LED DOWN LIGHT

LED 筒燈

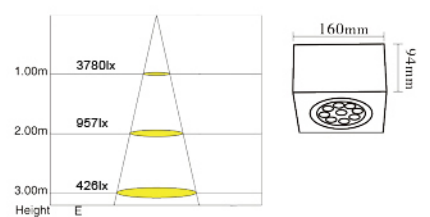
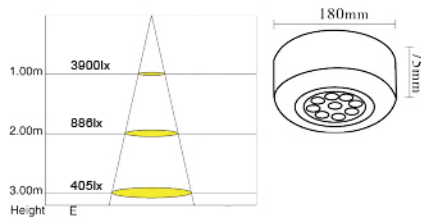
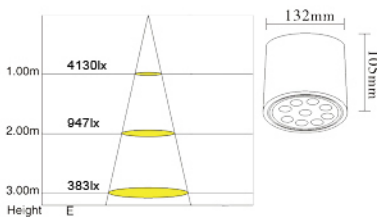

產品型號 Model	DL-13471	DL-13472	DL-13473
燈具功率 LED power	12W	12W	12W
輸入電壓 Input Voltage	AC100~240V	AC100~240V	AC100~240V
顯色指數 Color Rendering Index	Ra≥80	Ra≥80	Ra≥80
色溫 Color.t	3000~6000K	3000~6000K	3000~6000K
外殼材質 Case Material	鋁材 Aluminum	鋁材 Aluminum	鋁材 Aluminum
發光顏色 Emitting color	白光 /W 暖白 /WW	白光 /W 暖白 /WW	白光 /W 暖白 /WW



# LED STARS LIGHT

LED 星星燈



產品型號 Model	電壓 Voltage	長度 Length	總燈數 Total number of lamps	總瓦數 Total Wattage	顏色 Color	最大可串數 Maximum number of strings	LED 光源 Led light source	材質 Material
DL-13481	110V	10M	100pcs	5W	R Y B G W P	3 串	Ø3/ 3V/ 20mA	純塑料
	220V	10M	1000pcs	5W	PW RW YW BW RGBY			

# LED CURTAINS LIGHT

LED 網燈

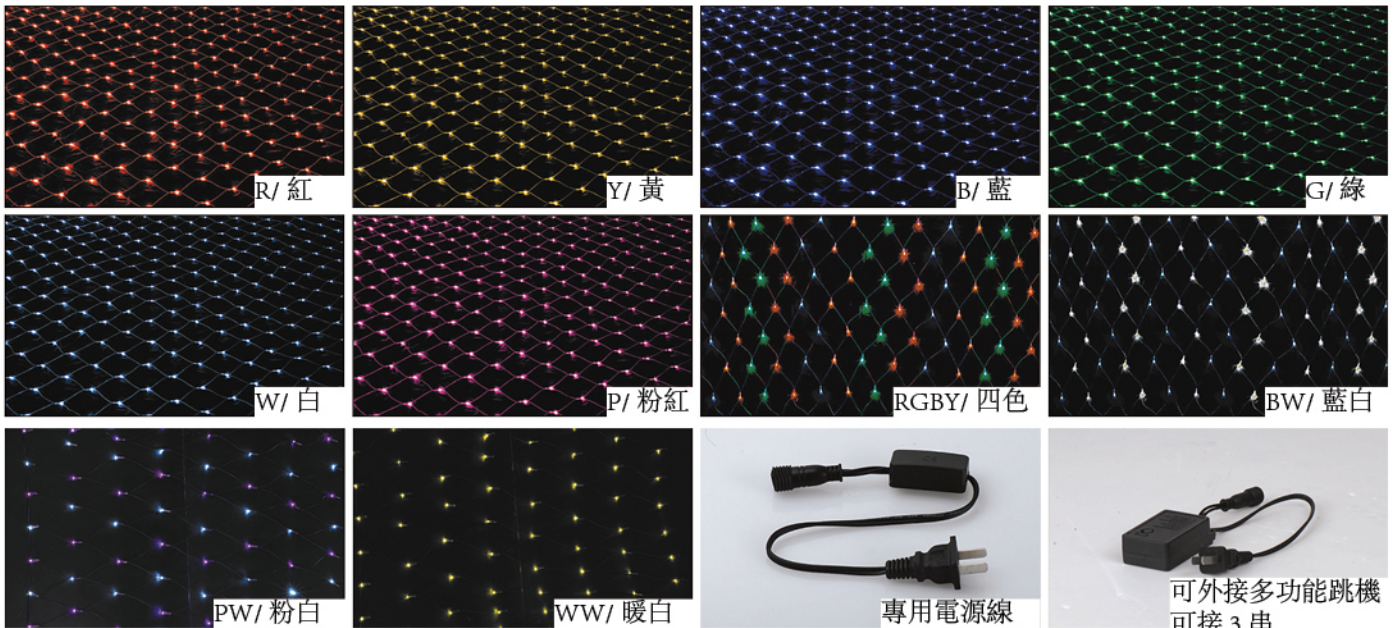

產品型號 Model	電壓 Voltage	長度 Length	總燈數 Total number of lamps	總瓦數 Total Wattage	顏色 Color	最大可串數 Maximum number of strings	LED 光源 Led light source	材質 Material
DL-13491	110V	1.8X1.2M	128pcs	8.8W	R Y B G W P	3 串	Ø3/ 3V/ 20mA	純塑料
	220V	1.8X1.2M	128pcs	8.8W	PW RW YW BW RGBY			

# LED ICICLE LIGHT

LED 冰條燈

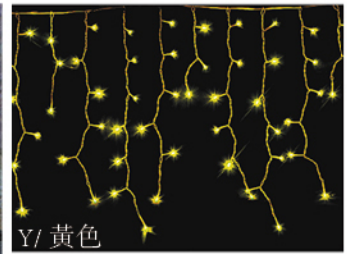

Y/ 黃色

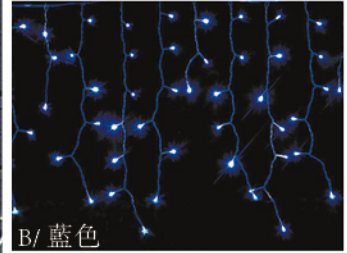

B/ 藍色

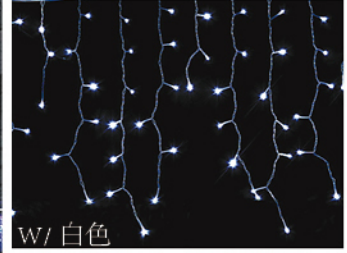

W/ 白色

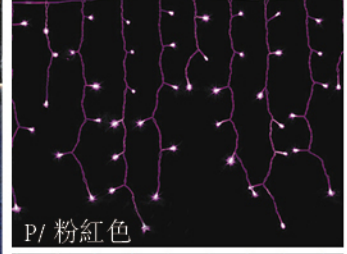

P/ 粉紅色



RGBY/ 四色



專用電源線



可串接多功能跳機，可接 3 串

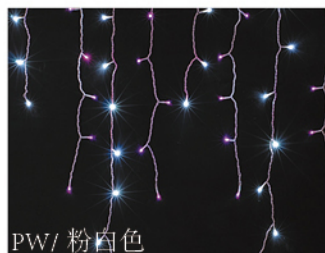

PW/ 粉白色



BW/ 藍白

產品型號 Model	電壓 Voltage	長度 Length	總燈數 Total number of lamps	總瓦數 Total Wattage	顏色 Color	最大可串數 Maximum number of strings	LED 光源 Led light source	材質 Material
DL-13501	110V	10M	100pcs	5W	Y B W P	3 串	Ø3/ 3V/ 20mA	純塑料
	220V	10M	1000pcs	5W	PW BW RGBY			

# LED CURTAINS LIGHT

LED 窗簾燈

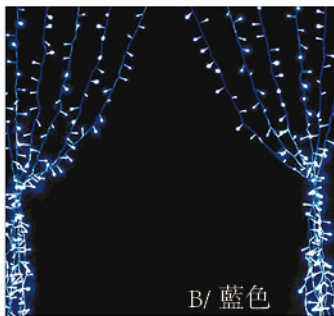
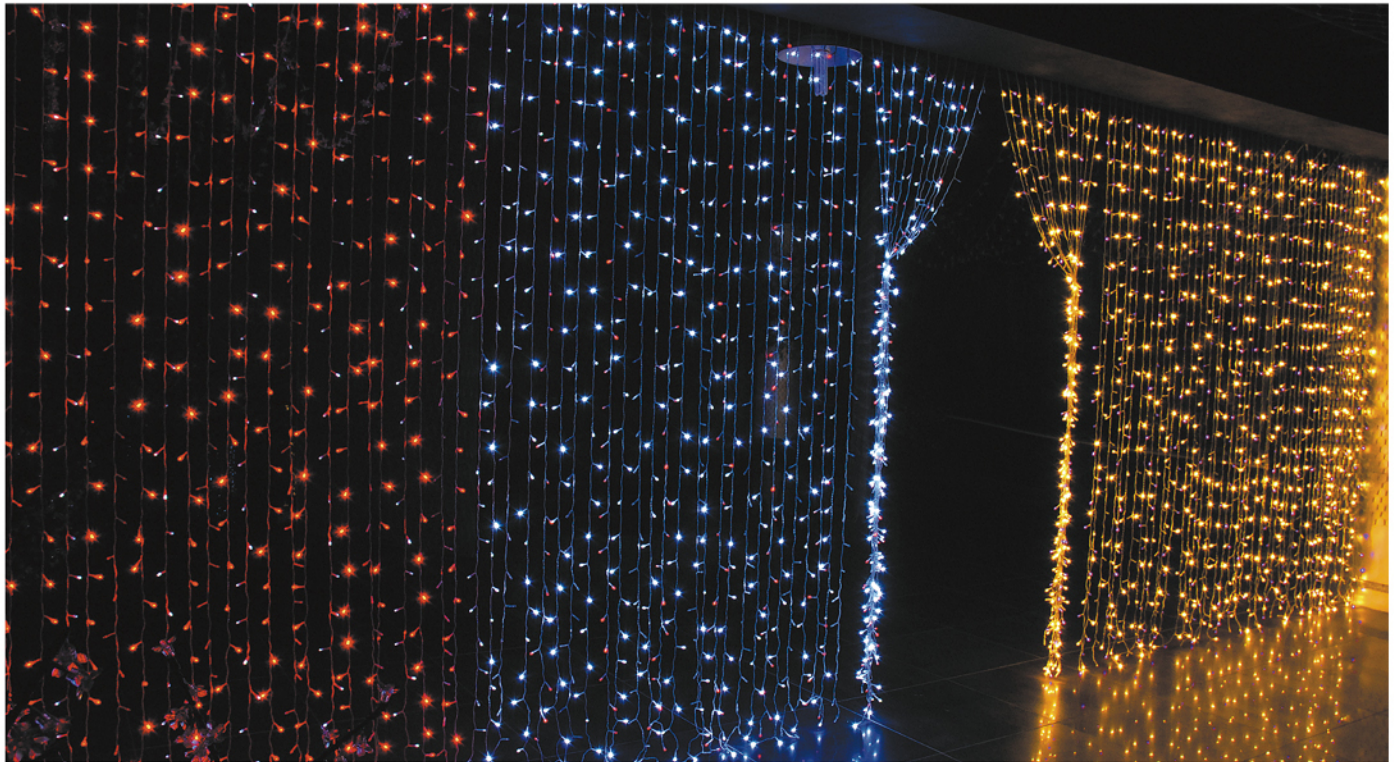

B/ 藍色



Y/ 黃色

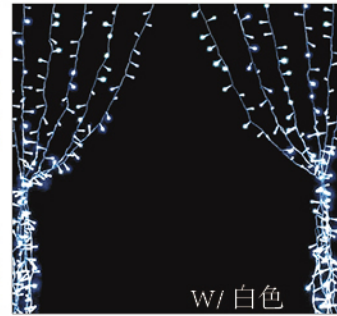

W/ 白色

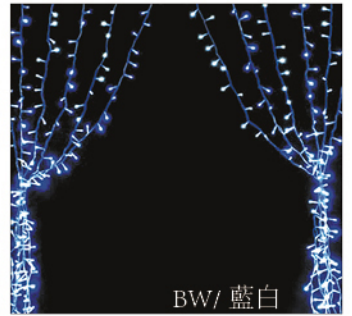

BW/ 藍白



P/ 粉紅色



專用電源線



可串接多功能跳機，可接 2 串

產品型號 Model	電壓 Voltage	長度 Length	總燈數 Total number of lamps	總瓦數 Total Wattage	顏色 Color	最大可串數 Maximum number of strings	LED 光源 Led light source	材質 Material
DL-13511	110V	2X2M	240pcs	18W	Y    B    BW    W    	2 串	Ø3/ 3V/ 20mA	純塑料
	220V	2X2M	240pcs	18W				
	110V	2X2M	208pcs	18W	P 			
	220V	2X2M	208pcs	18W				

# LED 貼片硬條燈

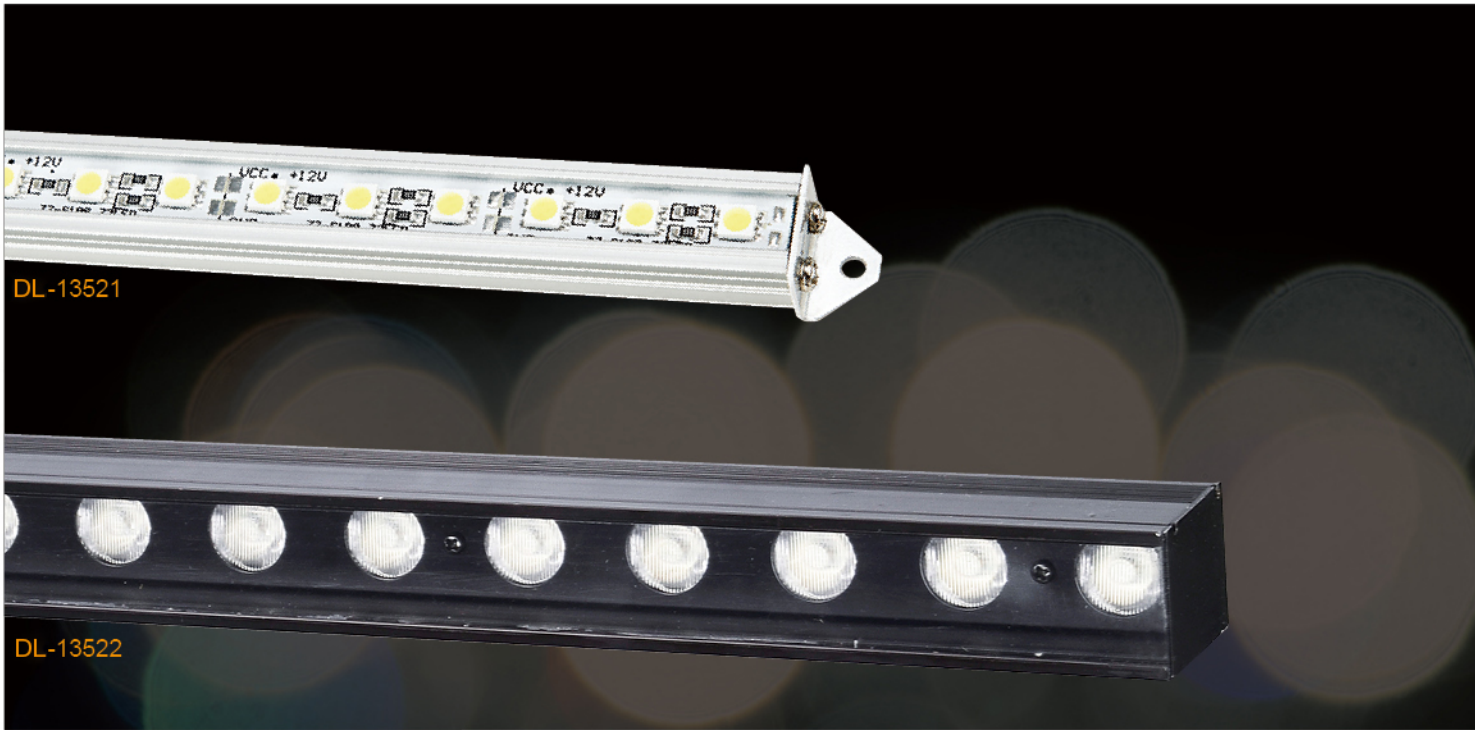

DL-13521

DL-13522

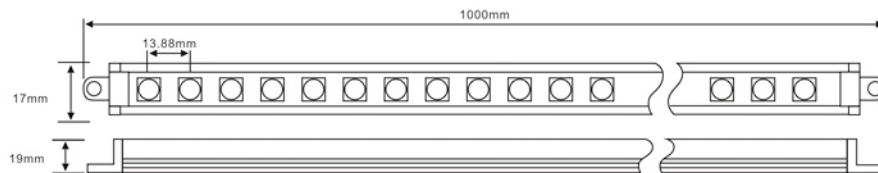

## ◆ 產品特點

採用臺灣大晶片安全可靠

AC 定電流專用電源

無熱輻射、紫外線、永保產品亮麗、不褪色

鋁合金散熱片外殼，散熱效果極佳，壽命長

採用平面光學透鏡、使光線更柔和

LED 取代傳統鹵素燈具，壽命是傳統的 8 倍

適合空間：精品展示、畫廊、珠寶櫥櫃、飯店、餐廳、情境照明、居家重點照明等

產品型號 Model	DL-13521	DL-13522
燈具功率 LED power	SMD 5050/60P 14.4W	50mm 1W x 15
輸入電壓 Input Voltage	DC12	DC24
顯色指數 Color Rendering Index	Ra≥80	Ra≥80
功率因素	>80%	>80%
色溫 Color.t	3000~6000K	2700K
外殼材質 Case Material	V 型鋁材 灌膠	鋁型材
發光顏色 Emitting color	白光 /W 暖白 /WW	暖白 /WW
防護等級 Protection Grade	IP44	IP44

\* 電源外置 依使用數量及方向選擇（價格另計）

\* 燈條長度及色溫 可依需求訂做

# LED 貼片硬條燈

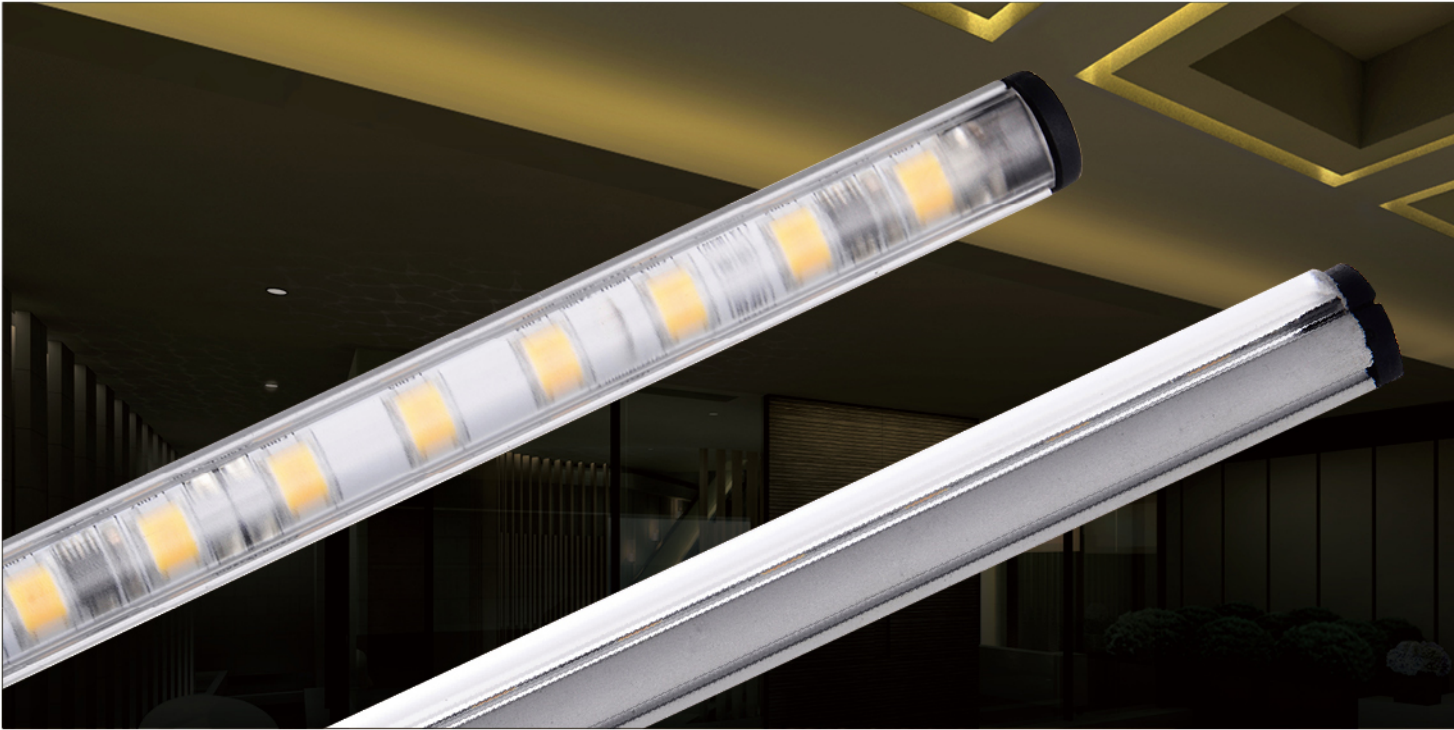

## Product characteristics

Adopting Taiwan Epistar Chip, more reliable  
 AC constant current power supply  
 No thermal radiation, no UV, Keep bright color for ever  
 Aluminum alloy heat sink shell, superior effects, long lifespan  
 Plane optical lens reflects softer rays of light  
 LED takes place of traditional halogen lamps, the lifespan is 8 times of the latter  
 Application: Boutique showcase, art gallery, jewelry cabinet, restaurant and dining room, situation lighting, home accent lighting, etc..

產品型號	功率 (w)	亮度 (Lm)	色溫	材質	輸入電壓	芯片	工作壽命	功率因數
DL-13531	9	600	3000K	Aluminium	AC85-265V /DC24V	LRU	30,000Hr	>90%
DL-13532	18	1200	6000K	Aluminium	AC85-265V /DC24V	LRU	30,000Hr	>90%

# SMD FLEXIBLE LIGHTS



## SMD 3528-30PCS

### + 產品特點

- 1- 每三個 LED 為一段，軟性印制電路板，背面帶雙面膠用於粘貼，體積小，安裝方便
- 2- 每卷的標準長度為 5M，每卷燈帶 LED 數量為 150PCS
- 3- 可選顏色：紅 / 黃 / 藍 / 綠 / 白 / 暖白
- 4- 工作電壓：DC12V
- 5- 產品根據用途分為：裸板、滴膠、硅膠、PVC 實心防水四種

# SMD FLEXIBLE LIGHTS



## 適用範圍

使用低压直流供电安全方便，超低功耗，发光颜色多样，色彩鲜艳；户外使用可以抗 UV 老化、抗高温等优势，可随意弯曲，可任意固定在凹凸表面，体积小，安装方便、长度可根据要求连接，光色无紫外线、无红外光辐射，光色无热量。

该产品广泛用于建筑物轮廓灯、广告装饰、珠宝展柜照明、橱柜照明、衣柜照明，专卖店装饰照明、灯光艺术照明、酒店、宾馆、居家别墅装饰照明等。



半裸型 (NK) IP20



滴膠防水型 (PU) IP44



套管防水型 (PC) IP65



灌膠防水型 (PC+PU) IP68

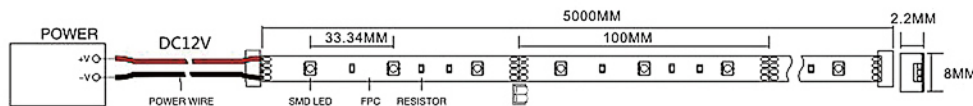

產品型號 Model	DL-13551	DL-13552	DL-13553	DL-13554	DL-13555	DL-13556
燈具功率 LED power	2.4W	2.4W	2.4W	2.4W	2.4W	2.4W
輸入電壓 Input Voltage	DC12V	DC12V	DC12V	DC12V	DC12V	DC12V
燈珠數量 LED Qty/ M	30 PCS	30 PCS	30 PCS	30 PCS	30 PCS	30 PCS
燈珠間距 LED spacing	33.34 mm	33.34 mm	33.34 mm	33.34 mm	33.34 mm	33.34 mm
裁剪長度 Cutting Unit	10cm	10cm	10cm	10cm	10cm	10cm
最大長度 Max length	5M	5M	5M	5M	5M	5M
顏色 Color	● R	● Y	● B	● G	● W	● WW



# SMD FLEXIBLE LIGHTS



## SMD 3528-60PCS

### ⊕ 產品特點

- 1- 每三個 LED 為一段，軟性印制電路板，背面帶雙面膠用於粘貼，體積小，安裝方便
- 2- 每卷的標準長度為 5M，每卷燈帶 LED 數量為 150PCS
- 3- 可選顏色：紅 / 黃 / 藍 / 綠 / 白 / 暖白
- 4- 工作電壓：DC12V
- 5- 產品根據用途分為：裸板、滴膠、硅膠、PVC 實心防水四種

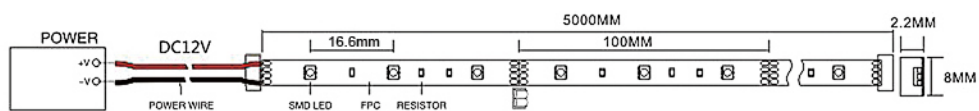

產品型號 Model	DL-13571	DL-13572	DL-13573	DL-13574	DL-13575	DL-13576
燈具功率 LED power	4.8W	4.8W	4.8W	4.8W	4.8W	4.8W
輸入電壓 Input Voltage	DC12V	DC12V	DC12V	DC12V	DC12V	DC12V
燈珠數量 LED Qty/ M	60 PCS	60 PCS	60 PCS	60 PCS	60 PCS	60 PCS
燈珠間距 LED spacing	33.34 mm	33.34 mm	33.34 mm	33.34 mm	33.34 mm	33.34 mm
裁剪長度 Cutting Unit	10cm	10cm	10cm	10cm	10cm	10cm
最大長度 Max length	5M	5M	5M	5M	5M	5M
顏色 Color	● R	● Y	● B	● G	● W	● WW

# SMD FLEXIBLE LIGHTS



## SMD 5050-60PCS

### ✦ 產品特點

- 1- 每三個 LED 為一段，軟性印制電路板，背面帶雙面膠用於粘貼，體積小，安裝方便
- 2- 每卷的標準長度為 5M，每卷燈帶 LED 數量為 150PCS
- 3- 可選顏色：紅 / 黃 / 藍 / 綠 / 白 / 暖白
- 4- 工作電壓：DC12V
- 5- 產品根據用途分為：裸板、滴膠、硅膠、PVC 實心防水四種

### ●適用範圍

使用低压直流供电安全方便，超低功耗，发光颜色多样，色彩鲜艳；户外使用可以抗 UV 老化、抗高温等优势，可随意弯曲，可任意固定在凹凸表面，体积小，安装方便、长度可根据要求连接，光色无紫外线、无红外光辐射，光色无热量。

该产品广泛用于建筑物轮廓灯、广告装饰、珠宝展柜照明、橱柜照明、衣柜照明、专卖店装饰照明、灯光艺术照明、酒店、宾馆、居家别墅装饰照明等。

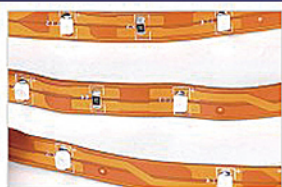
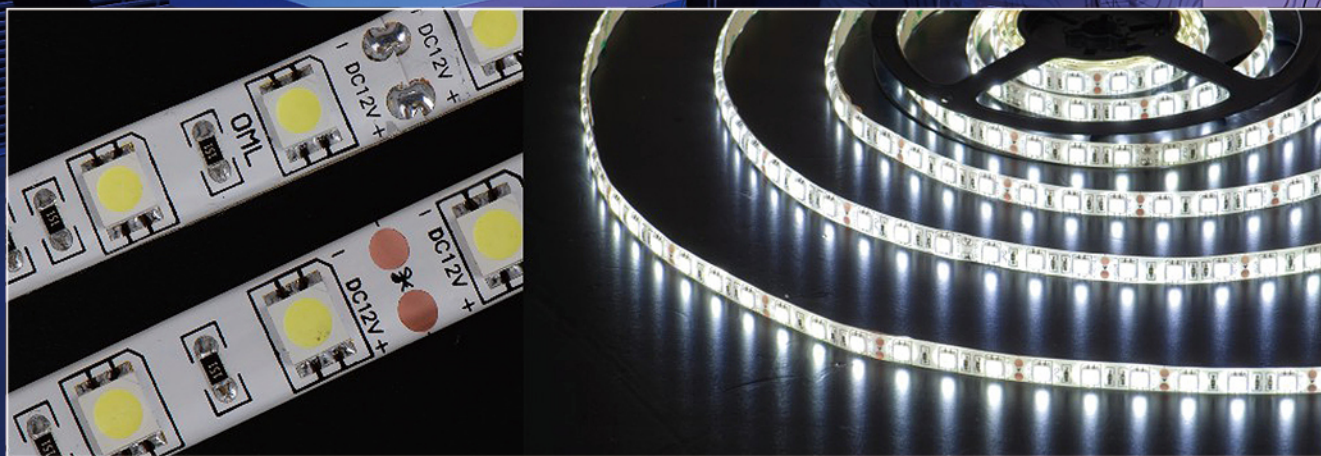

半裸型 (NK) IP20



滴膠防水型 (PU) IP44



套管防水型 (PC) IP65



灌膠防水型 (PC+PU) IP68

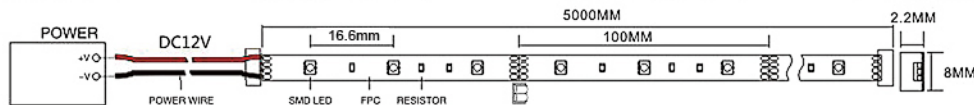

產品型號 Model	DL-13591	DL-13592	DL-13593	DL-13594	DL-13595	DL-13596
燈具功率 LED power	14.4W	14.4W	14.4W	14.4W	14.4W	14.4W
輸入電壓 Input Voltage	DC12V	DC12V	DC12V	DC12V	DC12V	DC12V
燈珠數量 LED Qty/ M	60 PCS	60 PCS	60 PCS	60 PCS	60 PCS	60 PCS
燈珠間距 LED spacing	16.6 mm	16.6 mm	16.6 mm	16.6 mm	16.6 mm	16.6 mm
裁剪長度 Cutting Unit	10cm	10cm	10cm	10cm	10cm	10cm
最大長度 Max length	5M	5M	5M	5M	5M	5M
顏色 Color	● R	● Y	● B	● G	● W	● WW

# SMD FLEXIBLE LIGHTS

## SMD 5050 幻彩 -36PCS

### + 產品特點

- 1- 每三個 LED 為一段，軟性印制電路板，背面帶雙面膠用於粘貼，體積小，安裝方便
- 2- 每卷的標準長度為 5M，每卷燈帶 LED 數量為 150PCS
- 3- 可選顏色：紅 / 黃 / 藍 / 綠 / 白 / 暖白
- 4- 工作電壓：DC12V
- 5- 產品根據用途分為：裸板、滴膠、硅膠、PVC 實心防水四種

# SMD FLEXIBLE LIGHTS



貼片軟條燈顏色有各種可選，滿足您各種場合的裝飾需求。營造獨特氛圍，個性自我！

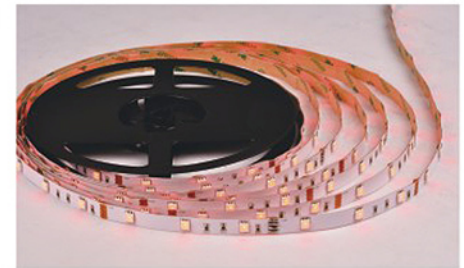
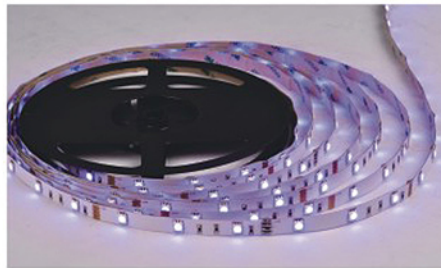
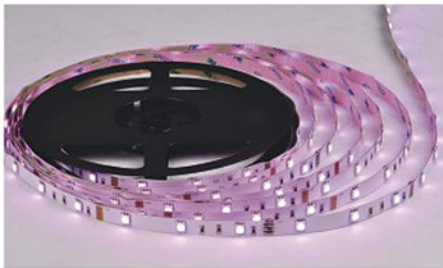
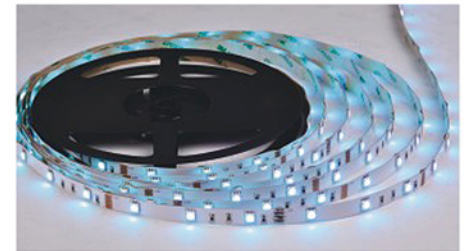
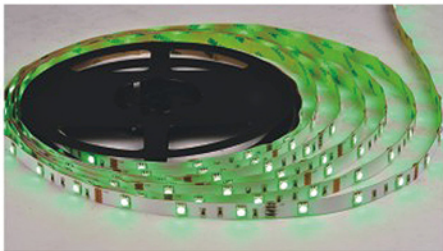

產品型號 Model	燈具功率 LED power	輸入電壓 Input Voltage	燈珠數量 LED Qty/ M	顏色 Color	流明 Lumen	波長 WaveLength	尺寸 Size
DL-13611	8.6W	DC12V	36	RGB	900lm	620~630K 465~470K 520~525K	1000x10x1.8mm

# SMD FLEXIBLE LIGHTS

## 軟條燈之配件及控制器



無線調光控制器



RGB 微控制器



RGB 微控制器



控制調光器



手動遙控調光器

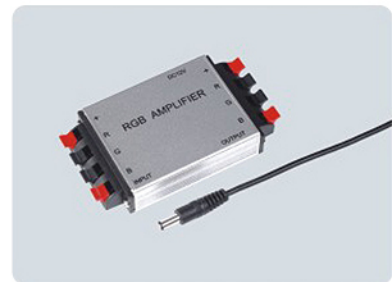

RGB 信號放大器



防水電源



不防水電源

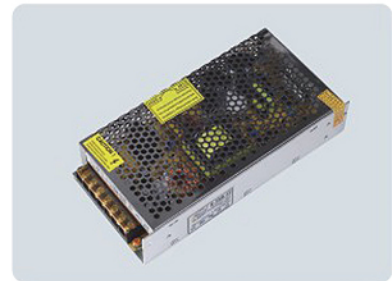

不防水開關電源

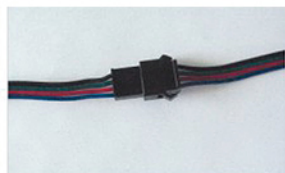

公母連接器 (不防水)  
RGB



公母連接器 (不防水)  
RGB



公母連接器 (不防水)  
單色



公母連接器 (防水)  
單色

# 3528 SMD HIGH-PRESSURE FLEXIBLELIGHT-60

3528 SMD 高壓貼片軟條燈 -60

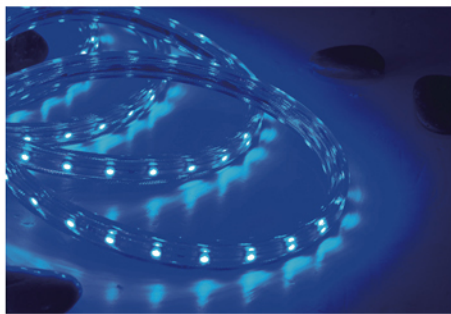
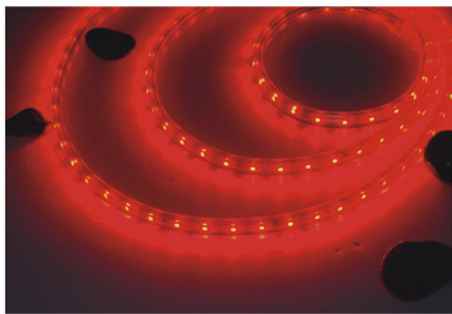
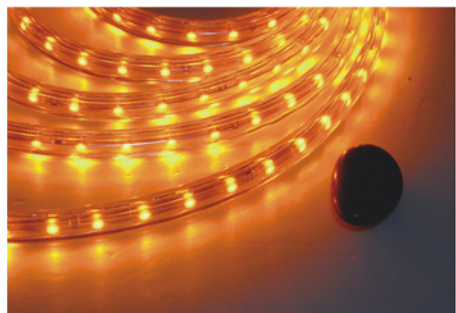

產品型號 Model	電壓 Voltage	長度 Length	燈珠數 Total number of lamps	每米功率 Each m power	顏色 Color	發光角度 Beam angle	備註 Remarks
DL-13631	110V	0.5M	30pcs	8.8W	R    Y    B ●   ●   ● G    W    WW ●   ●   ●	120°	紅黃藍綠可定製
	220V	1M	60pcs	8.8W			



# 5050 SMD HIGH-PRESSURE FLEXIBLELIGHT-30

5050 SMD 高壓貼片軟條燈 -30

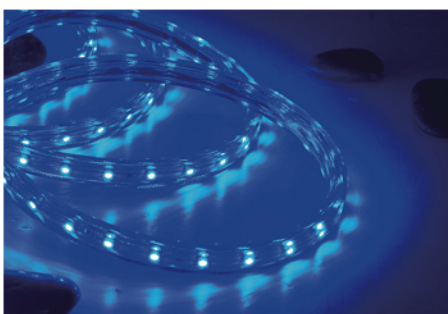
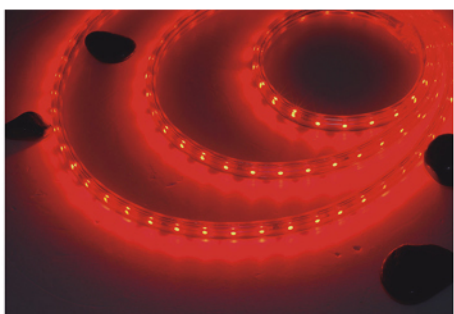

產品型號 Model	電壓 Voltage	長度 Length	燈珠數 Total number of lamps	每米功率 Each m power	顏色 Color	發光角度 Beam angle	備註 Remarks
DL-13641	110V	0.5M	15pcs	7.5W	R    Y    B ●   ●   ● G    W    WW ●   ●   ●	120°	紅黃藍綠可定製
	220V	1M	30pcs	7.5W			

# 5050 SMD HIGH-PRESSURE FLEXIBLELIGHT-60

5050 SMD 高壓貼片軟條燈 -60

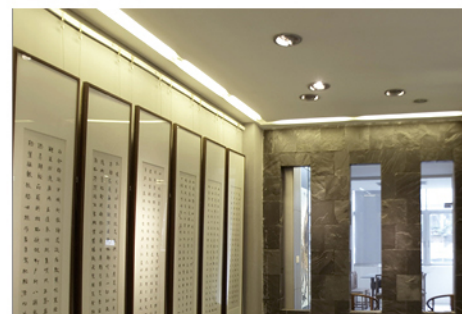
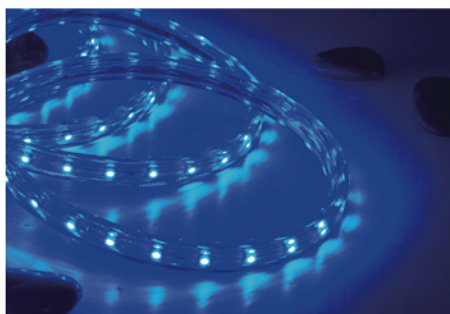
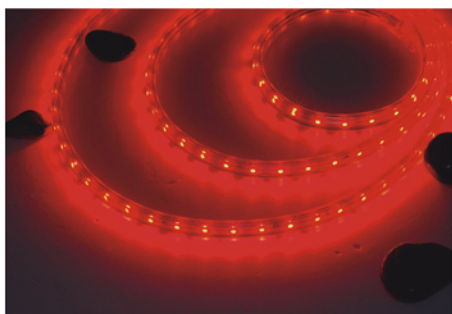
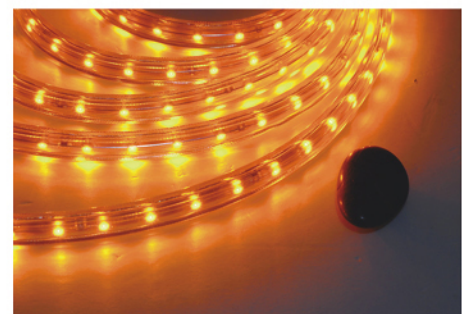

產品型號 Model	電壓 Voltage	長度 Length	燈珠數 Total number of lamps	每米功率 Each m power	顏色 Color	發光角度 Beam angle	備註 Remarks
DL-13651	110V	0.5M	30pcs	15W	R    Y    B ●   ●   ● G    W    WW ●   ●   ●	120°	紅黃藍綠可定製
	220V	1M	60pcs	15W			

# ROUND 2-WIRE ROPE LIGHT

圓二線 彩虹管

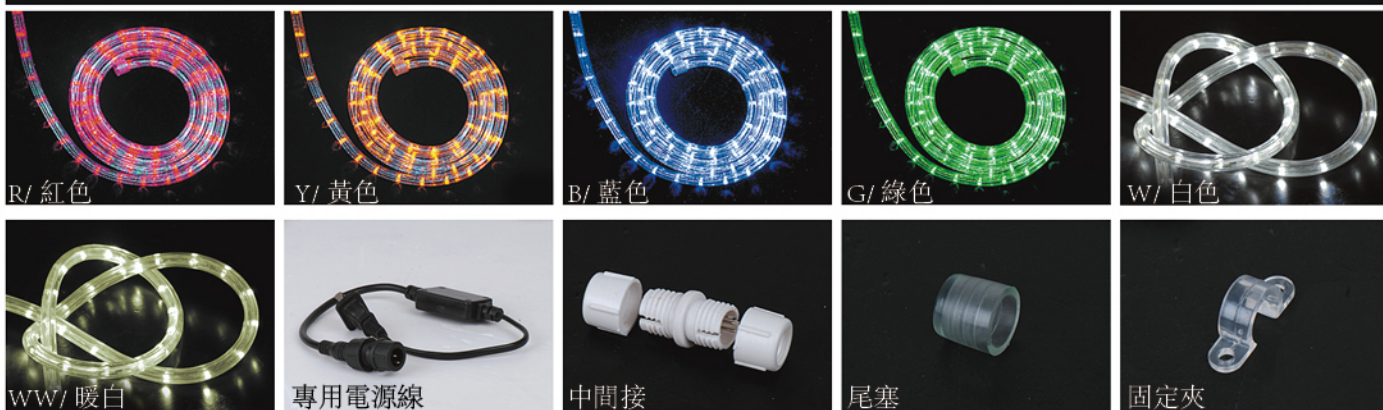
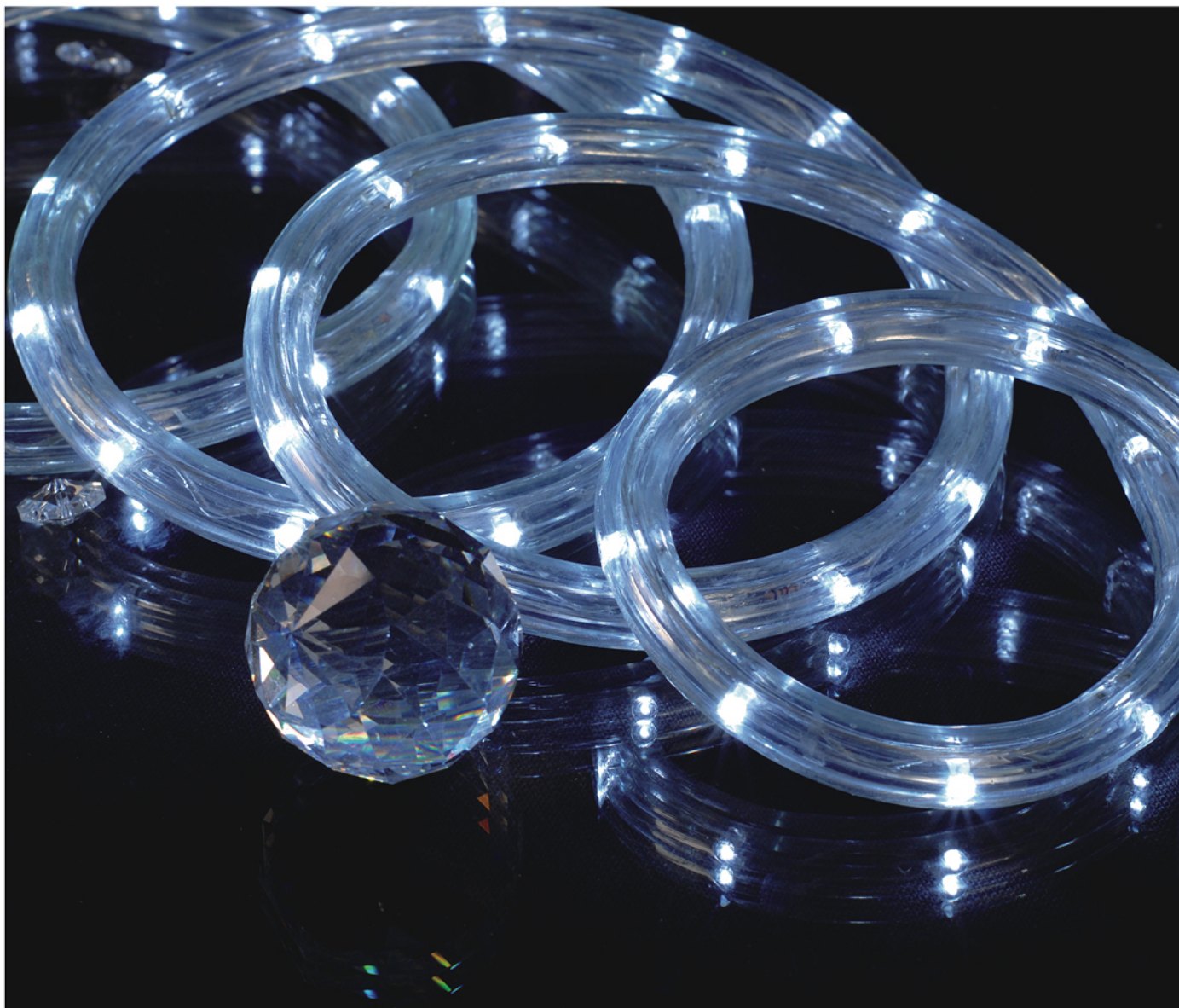

產品型號 Model	電壓 Voltage	直徑 Diameter	燈珠數 Total number of lamps	每米功率 Each m power	顏色 Color	每卷長度 Length	最大使用長度 Max using length
DL-13661	110V	13mm	36pcs	2.2W	R Y B ● ● ●	50M	100M
	220V	13mm	72pcs	4.5W	G W ● ● ● ●		

# ROUND 3-WIRE ROPE LIGHT

圓三線 彩虹管

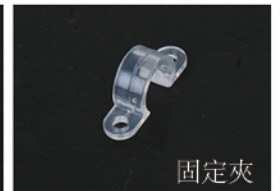
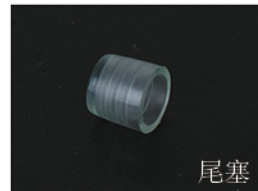
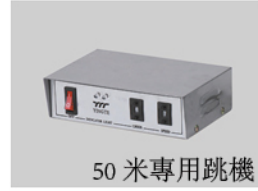
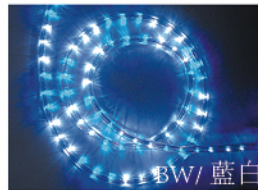
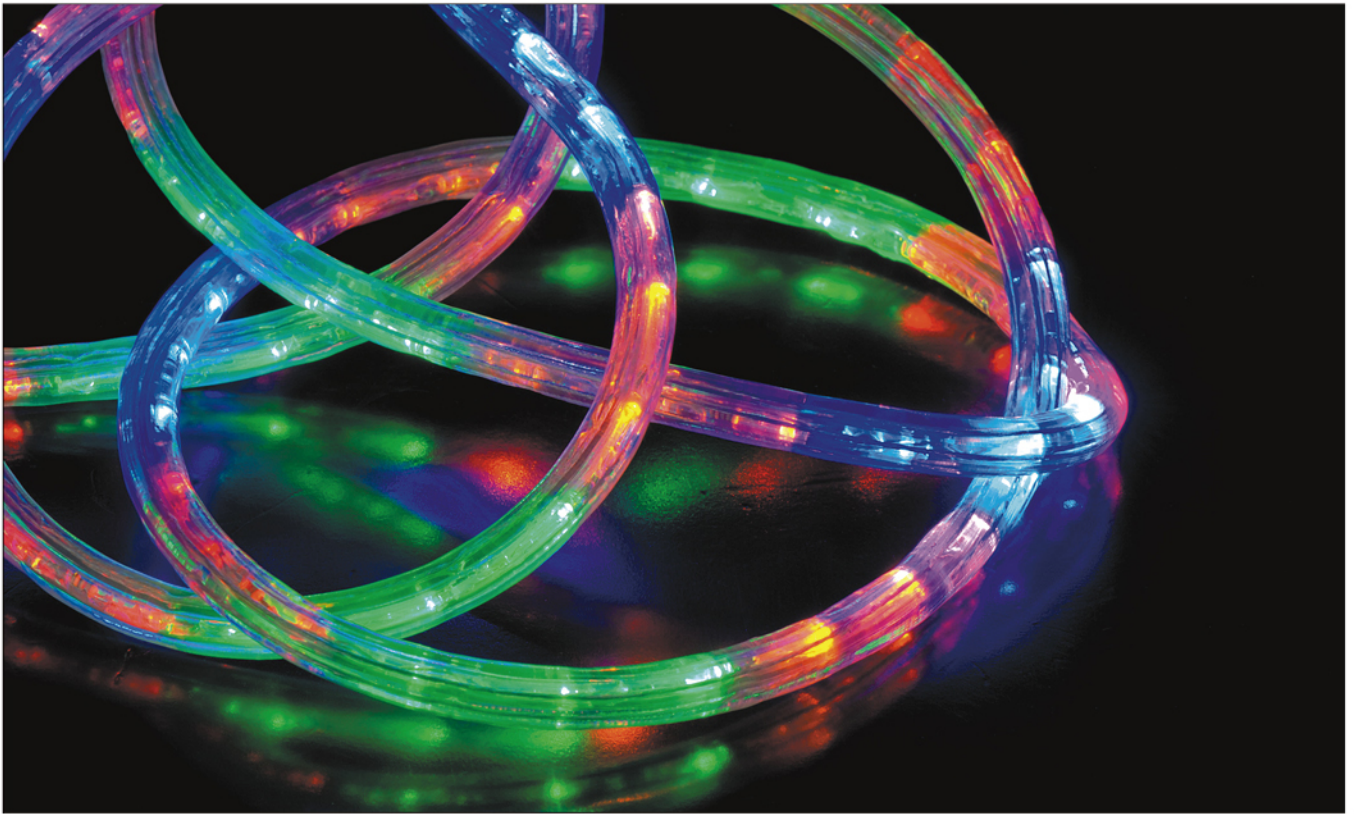

產品型號 Model	電壓 Voltage	直徑 Diameter	燈珠數 Total number of lamps	每米功率 Each m power	顏色 Color	每卷長度 Length	最大使用長度 Max using length
DL-13671	110V	13mm	72pcs	4.4W	BW	50M	100M
	220V	13mm	72pcs	4.4W	RGBY		

# FLAT 3-WIRE ROPE LIGHT

扁三線 彩虹管

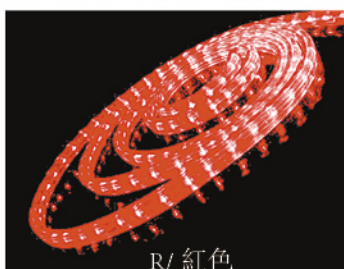

R/ 紅色



Y/ 黃色

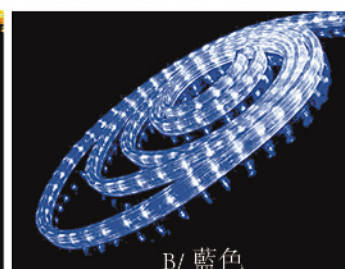

B/ 藍色

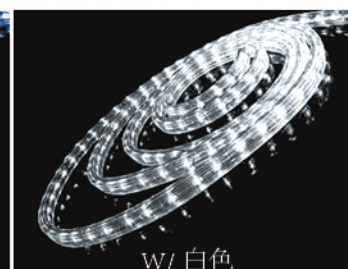

W/ 白色



RB/ 紅藍

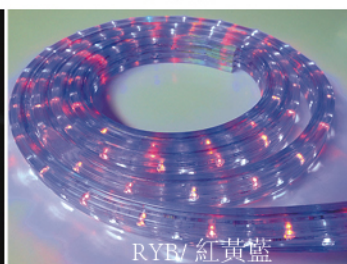

RYB/ 紅黃藍



專用電源綫



20 米專用跳機



50 米專用跳機

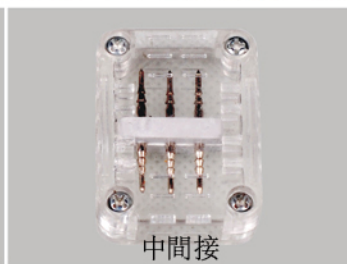

中間接

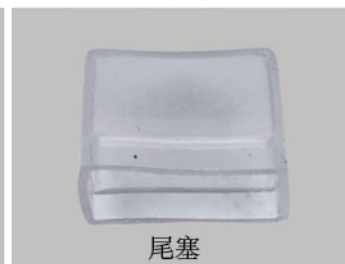

尾塞



固定夾

產品型號 Model	電壓 Voltage	直徑 Diameter	燈珠數 Total number of lamps	每米功率 Each m power	顏色 Color	每卷長度 Length	最大使用長度 Max using length
DL-13681	110V	11x18mm	72pcs	4.4W	R    Y    B ●   ●   ● RYB W RB ●   ●   ●	50M	100M
	220V	11x18mm	114pcs	8.8W			

# FLAT 3-WIRE ROPE LIGHT

扁三線 彩虹管

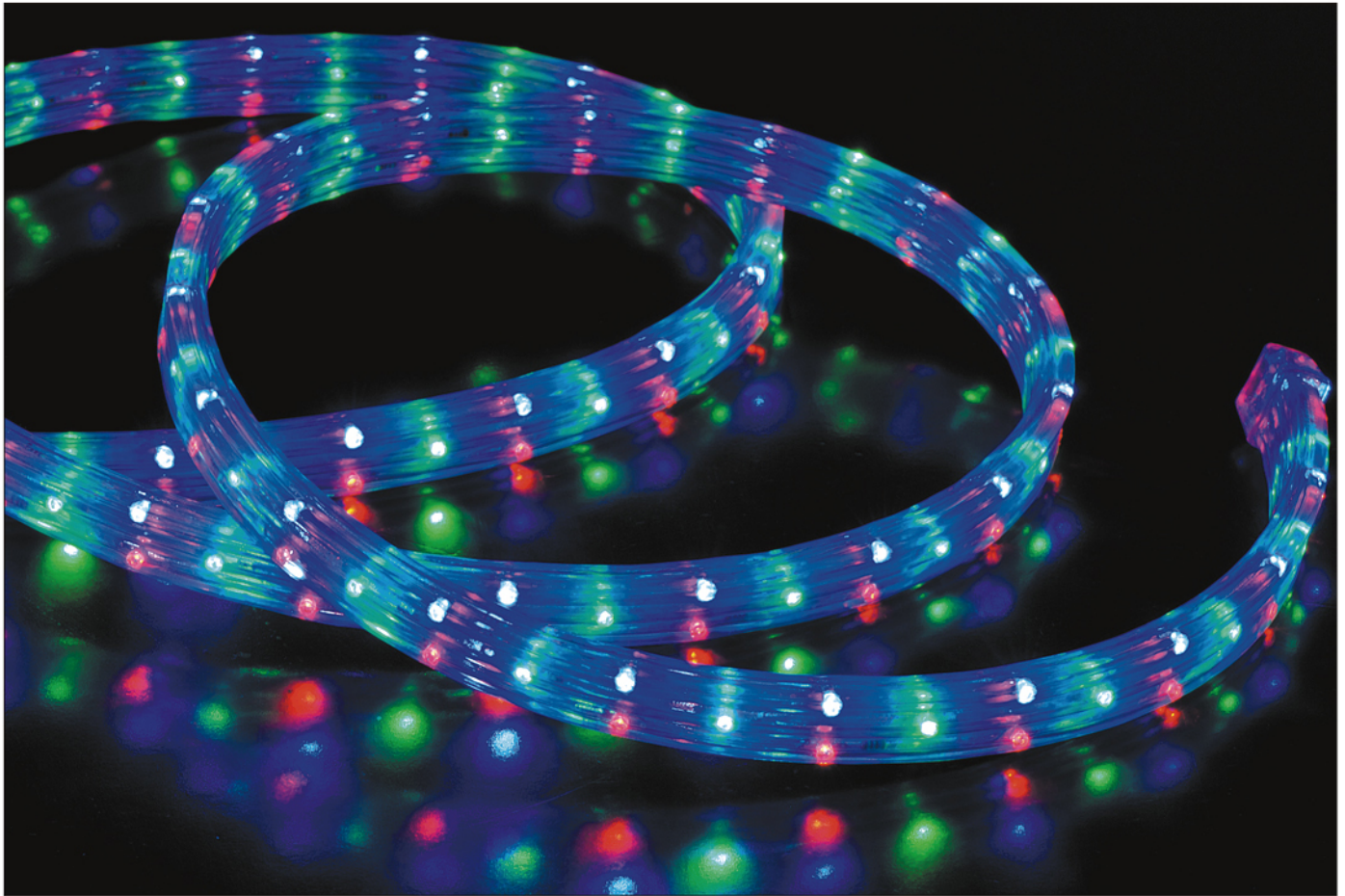

專用電源綫



20 米專用跳機



50 米專用跳機

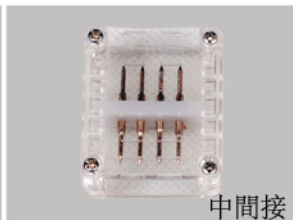

中間接

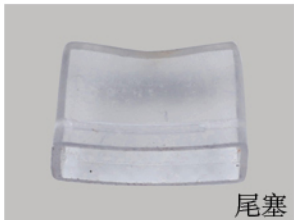

尾塞

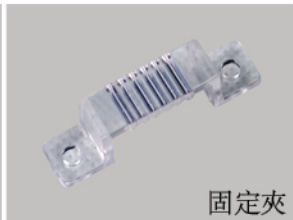

固定夾



產品型號 Model	電壓 Voltage	直徑 Diameter	燈珠數 Total number of lamps	每米功率 Each m power	顏色 Color	每卷長度 Length	最大使用長度 Max using length
RH-13691	110V	11x23mm	108pcs	6.5W	RGB 	50M	100M
	220V	11x23mm	108pcs	13W			

# FLAT 5-WIRE ROPE LIGHT

扁五線 彩虹管

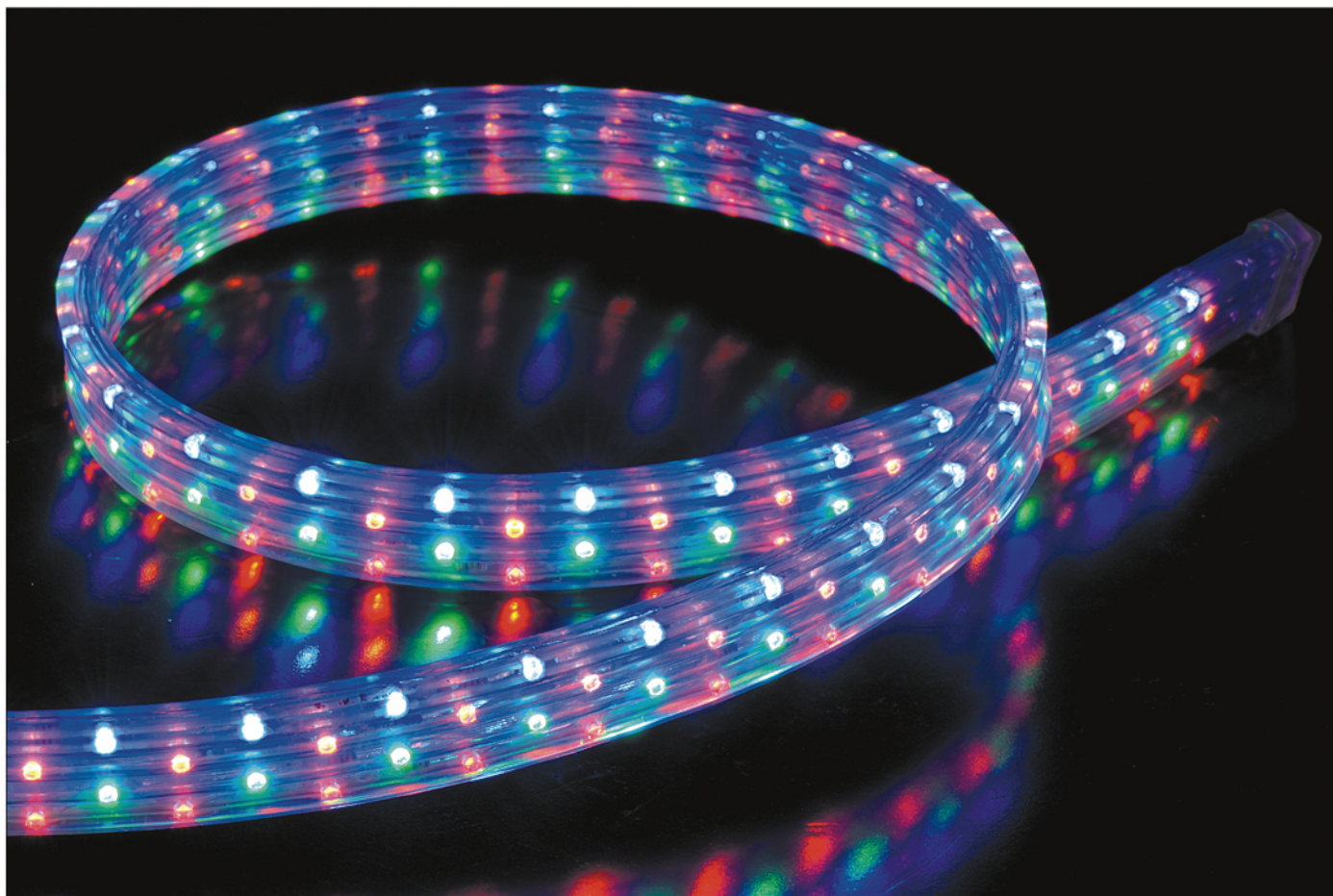

R/ 紅色



Y/ 黃色



B/ 藍色



W/ 白色



RYGB/ 四色



專用電源綫



20 米專用跳機



50 米專用跳機

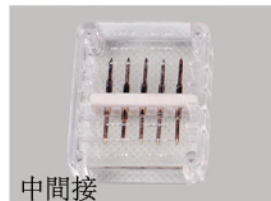

中間接

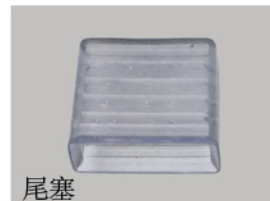

尾塞

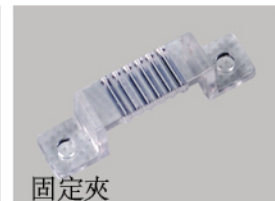

固定夾

產品型號 Model	電壓 Voltage	直徑 Diameter	燈珠數 Total number of lamps	每米功率 Each m power	顏色 Color	每卷長度 Length	最大使用長度 Max using length
DL-13701	110V	11x29mm	114pcs	8.7W	R Y B ● ● ● RYGB W ● ● ● ●	50M	100M
	220V	11x29mm	288pcs	17.5W			

# SMD METEOR LIGHT

SMD 流星燈



## 產品特點

- 1- 採用超高亮度 SMD LED 節能環保
- 2- 特殊的光學設計，提高有效光輸出，亮度高
- 3- 壽命長達 50,000 小時
- 4- 室內外  $-20^{\circ}\sim 50^{\circ}$  均可正常使用，IP65 防護等級
- 5 安裝方便

1.Made of super brightness SMD LED,energy saving and green product.

2.Special optical design,more effective light output,super high brightness.

3.Fewer light degradation,50000 hours lifespan.

4.Interior-  $20^{\circ}\sim 50^{\circ}$  degrees the noemal use Ip65 protection grade.

5.Easy installation.

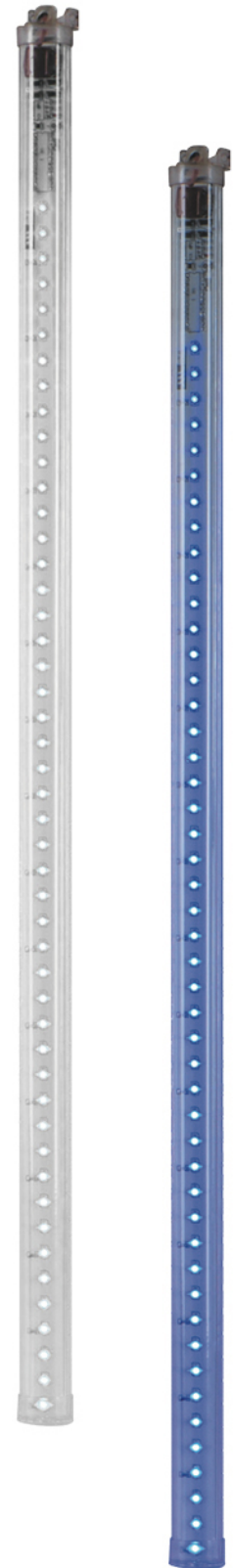

產品型號 Model	功率 power	輸入電壓 Input Voltage	燈珠數量 LED Qty/ M	顏色 Color	發光角度 Beam angle	環境溫度 W.encionment	材質 Material	防水等級 Protection Grade	尺寸 Size
DL-13711	2W	AC110/220V	96PCS	W ●	120°	$-20^{\circ}\sim 50^{\circ}$	PMMA	IP65	25X720mm
DL-13712	2W	AC110/220V	96PCS	W ●	120°	$-20^{\circ}\sim 50^{\circ}$	PMMA	IP65	25X720mm



# LED BETEL NUT LIGHT

LED 檳榔燈

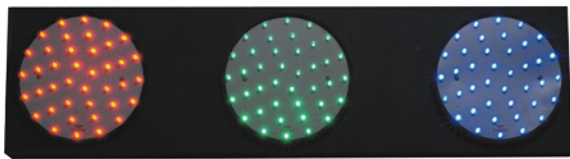

KH-13721



顏色		功能與特點
尺寸	755x 200mm	採用超高亮度 LED 為光源 三色變化跳動, 防水設計, 壽命長, 超省電, 安全性強, 是最佳明顯招牌。
工作電壓	AC110/ 220V	
光源	LED	
發光角度	水平 15° 垂直 10°	
燈數	紅, 藍, 綠各 40 燈	



# 5050 SMD ADCERSTISING WATERPROOF MODULE

5050 SMD 廣告防水模糊

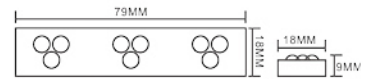
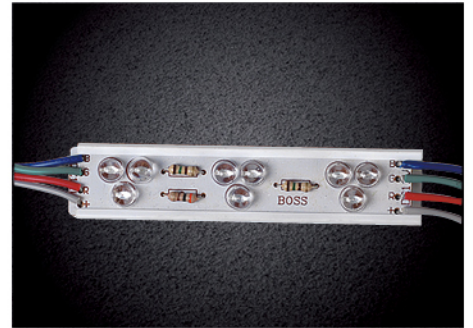
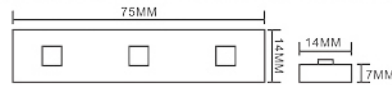
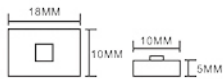
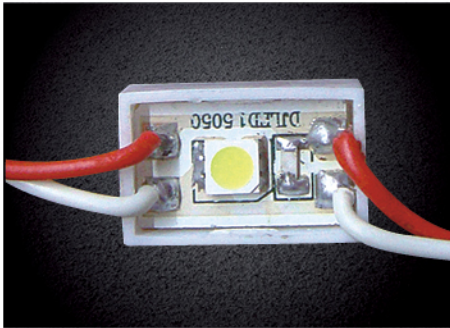

## ◆ 產品特點

- 1- 採用 LED 作為光源，節能環保
- 2- 亮度高，發光角度大，顏色均勻
- 3- 12V 低壓驅動，安全可靠
- 4- 防水模組系列，可達到 IP65 防護等級
- 5- 全彩模組系列，配套提供控制器，色彩變化效果豐富



產品型號 Model	功率 power	輸入電壓 Input Voltage	燈珠數量 LED Qty/ M	顏色 Color	色溫 Color tem	防水等級 Protection Grade	尺寸 Size
DL-13731	0.24W	DC12V	1PCS	● R	620~630K	IP65	22x14mm
DL-13732	0.24W	DC12V	1PCS	● B	460~470K	IP65	22x14mm
DL-13733	0.24W	DC12V	1PCS	● W	5000~6500K	IP65	22x14mm
DL-13734	0.72W	DC12V	3PCS	● B	460~470K	IP65	75x15mm
DL-13735	0.72W	DC12V	3PCS	● W	5000~6500K	IP65	75x15mm
DL-13736	0.72W	DC12V	9PCS	● RGB	5000~6500K	IP65	75x18mm

# LED ADVERTISING WATERPROOF MODULE

LED 廣告招牌燈

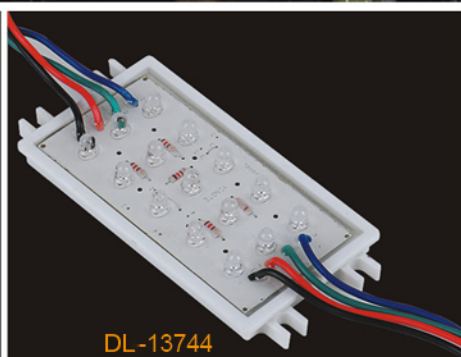

產品型號 Model	功率 power	輸入電壓 Input Voltage	燈珠數量 LED Qty/ M	顏色 Color	色溫 Color tem	防水等級 Protection Grade	尺寸 Size
DL-13741	1W	DC12V	8PCS	W	620~630K	IP65	26x36x26mm
DL-13742	1W	DC12V	8PCS	RGBY	460~470K	IP65	26x36x26mm
DL-13743	0.5W	DC12V	15PCS	R	5000~6500K	IP65	100x50mm
DL-13744	0.5W	DC12V	15PCS	W	460~470K	IP65	100x50mm
DL-13745	0.5W	DC12V	15PCS	B	460~470K	IP65	100x50mm
DL-13746	0.5W	DC12V	15PCS	G	520~230K	IP65	100x50mm

# LED MONOCHROME DIAMOND LIGHT

LED 單色鑽石燈

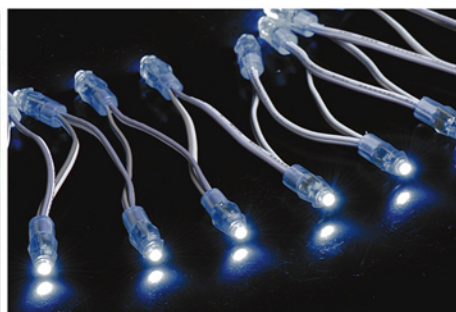
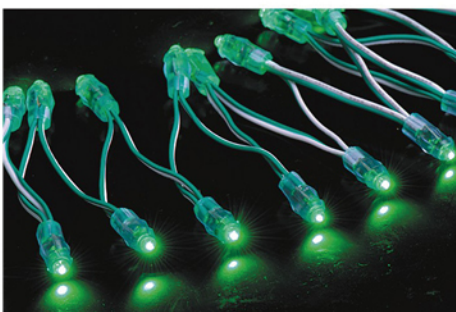
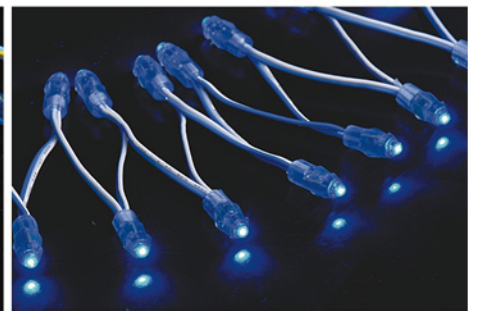
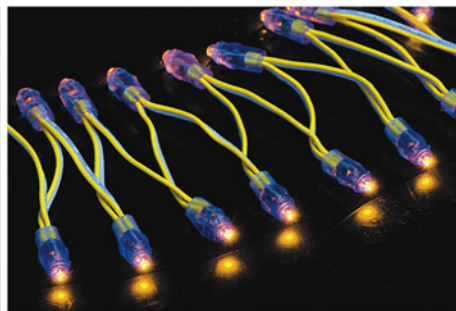
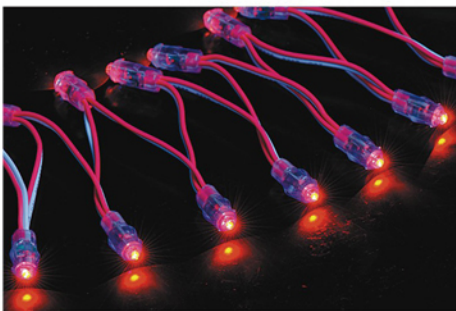
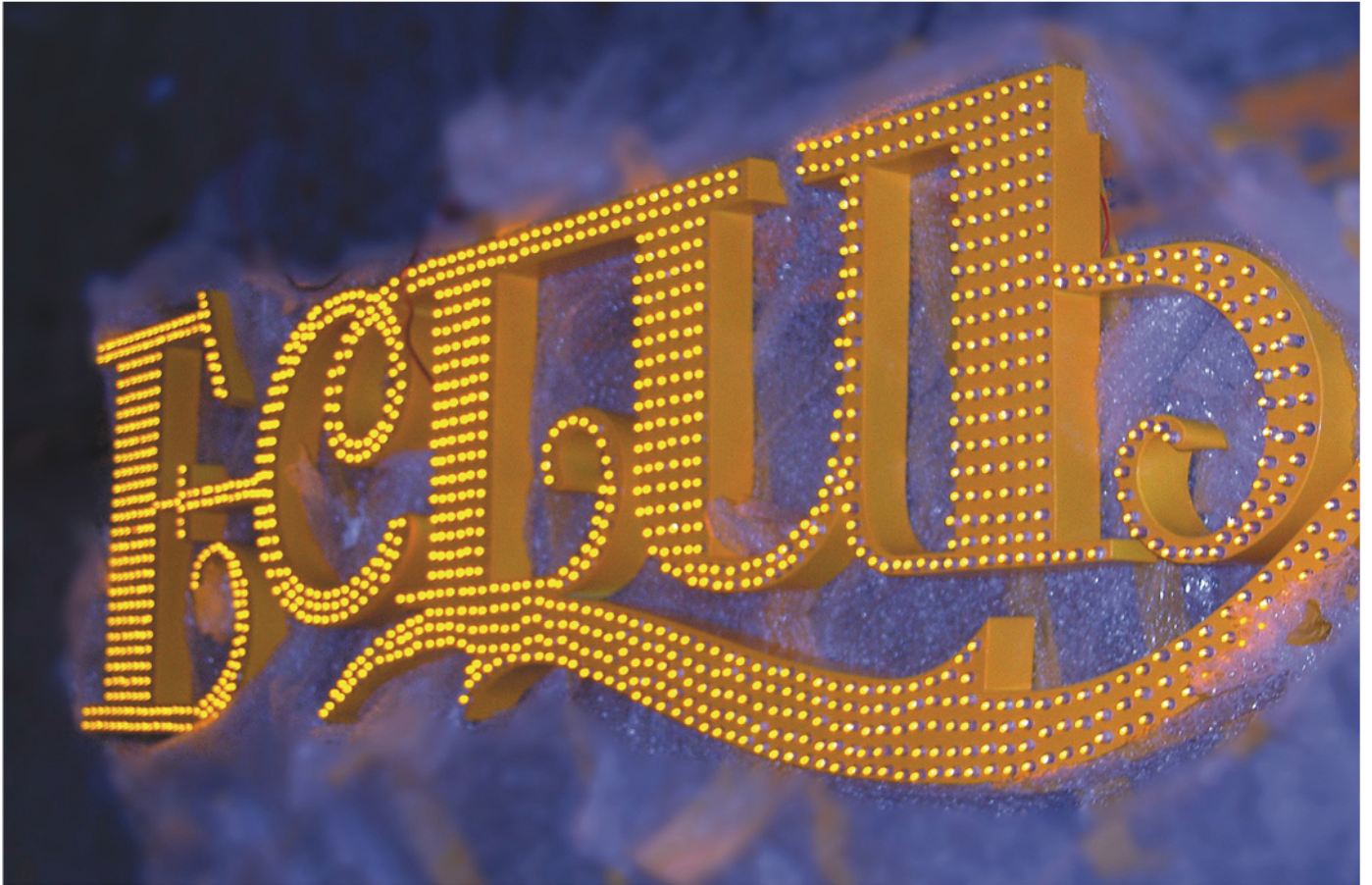

產品型號 Model	功率 power	電源 Power	光源壽命 Light source	燈珠數量 Number of lamps	燈珠規格 Light source	顏色 Color	工作溫度 working Tmp	防水等級 Protection Grade
DL-13751	0.2W	DC5V	50,000Hrs	50PCS/ 串	Ø5mm	R Y B G W ● ● ● ● ●	-20C°~50C°	IP67

# LED COLORFUL DIAMOND LIGHT

LED 七彩鑽石燈

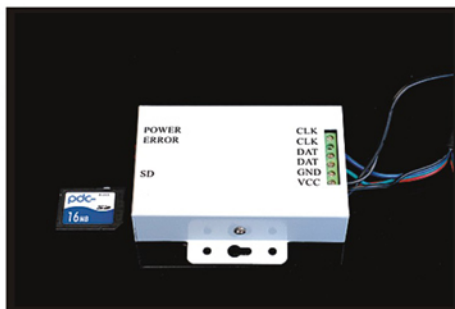
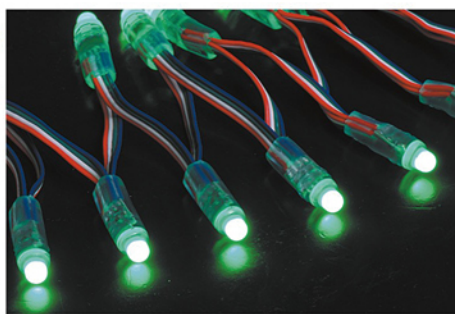
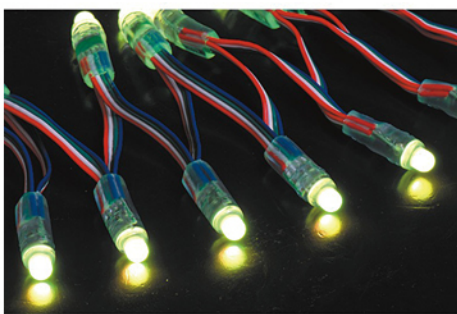
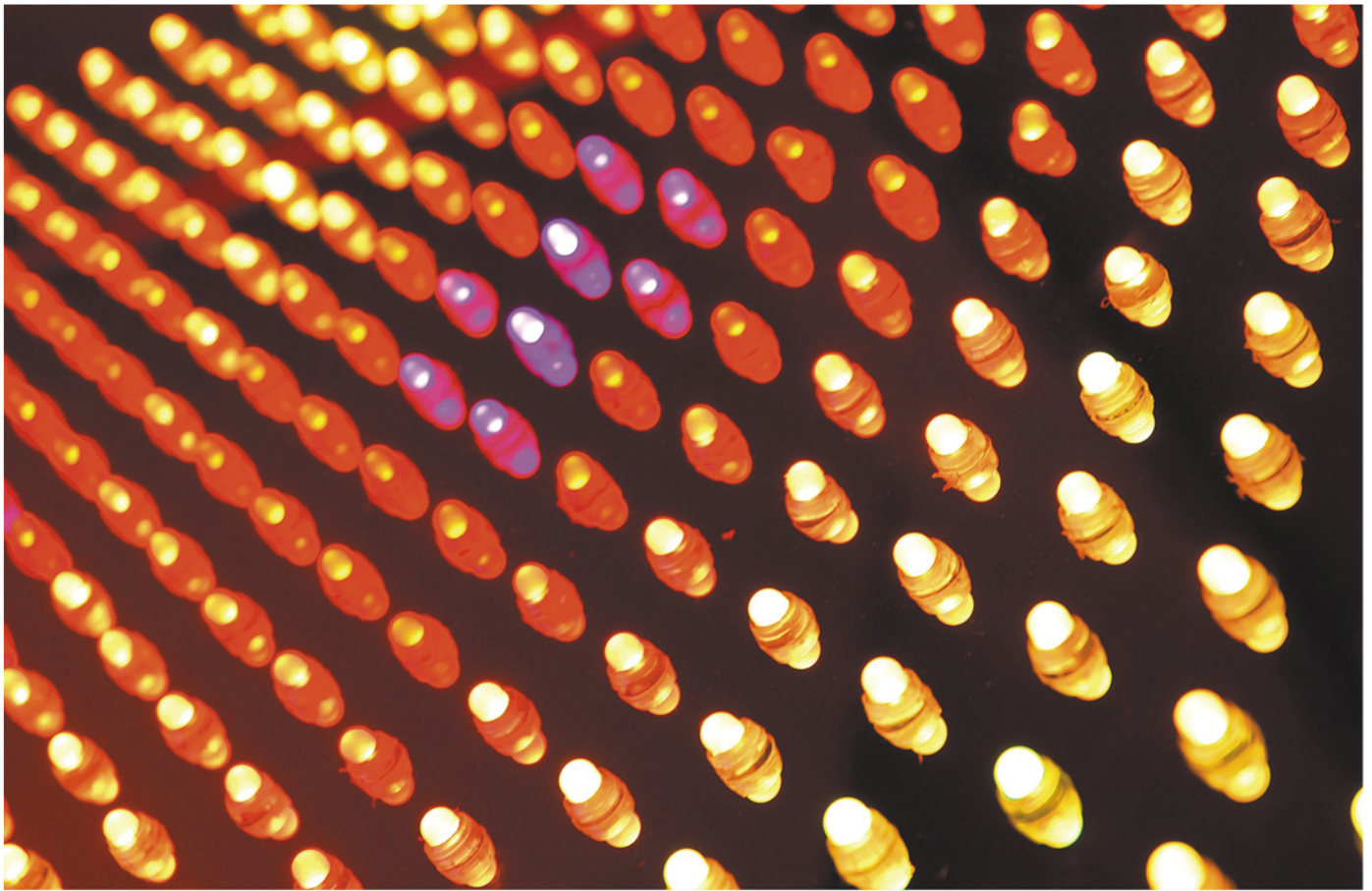

產品型號 Model	功率 power	電源 Power	光源壽命 Light source	燈珠數量 Number of lamps	燈珠規格 Light source	顏色 Color	工作溫度 working Tmp	防水等級 Protection Grade
DL-13761	0.2W	DC5V	50,000Hrs	50PCS/ 串	Ø5mm	RGBY	-20C <sup>o</sup> ~50C <sup>o</sup>	IP67

# SLED SUBTILE MACHINE

LED 字幕機

## SLED SUBTILE MACHINE



DL-13771



規格	55 x 11.5 x 2.5 cm
像素構成	1R
LED 燈數	2048PCS
顯示點數	16 x 128PCS
瓦數	5W
用途	會議場所、飯店櫃檯、展覽會、辦公室、銀行、證券公司、商店櫥窗

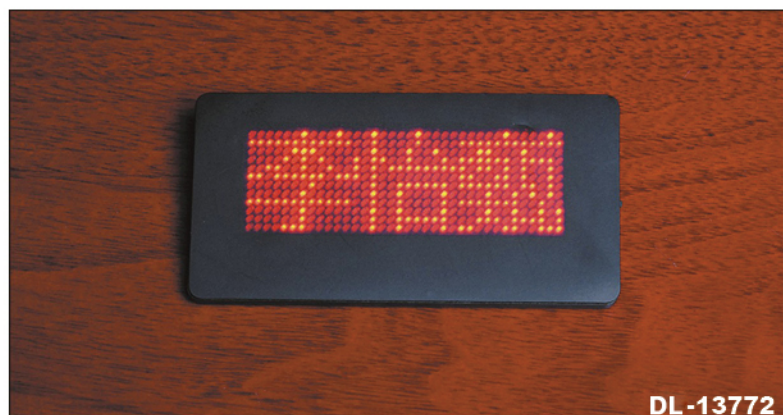

DL-13772



規格	90 x 45.5 x 8 mm
像素構成	1R
LED 燈數	432PCS
顯示點數	12 x 368PCS
瓦數	5W
用途	機場、商場、醫院、銀行、保齡球館、中高檔社區、旅遊景點、展覽展示及電子數碼城內商戶人員佩戴或擺飾

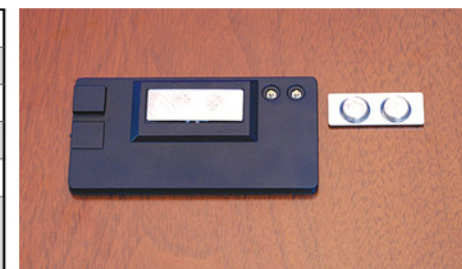

# LED Jewellery cabinets lamps



# LED Jewellery cabinets lamps

LED 珠寶櫥櫃展示燈



DL-13791

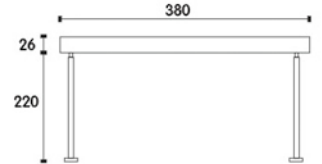

DL-13792

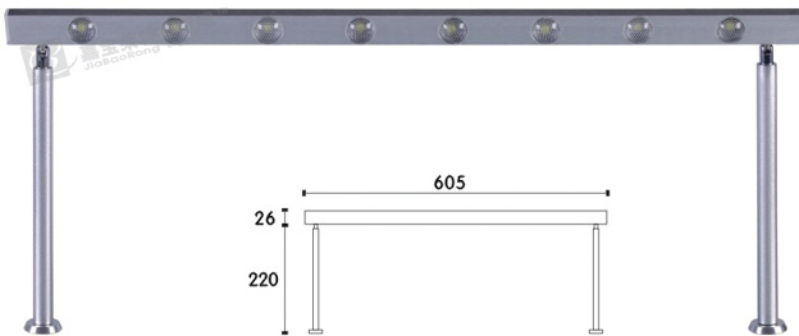
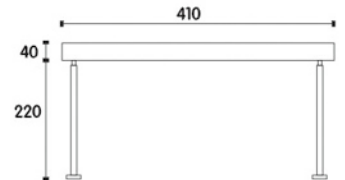

DL-13793

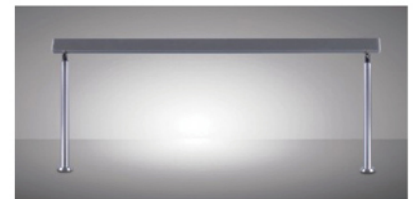
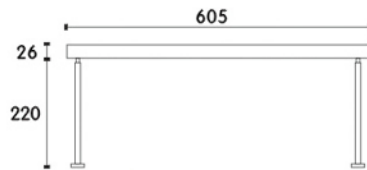

產品型號 Model	DL-13791	DL-13792	DL-13793
燈具功率 LED power	1W x 5	3W x 4	1W x 8
輸入電壓 Input Voltage	AC100~240V	AC100~240V	AC100~240V
顯色指數 Color Rendering Index	Ra≥80	Ra≥80	Ra≥80
色溫 Color.t	3000~6000K	3000~6000K	3000~6000K
外殼材質 Case Material	鋁材 Aluminum	鋁材 Aluminum	鋁材 Aluminum
發光顏色 Emitting color	白光 / 暖白	白光 / 暖白	白光 / 暖白



# LED Jewellery cabinets lamps

LED 珠寶櫥展示燈

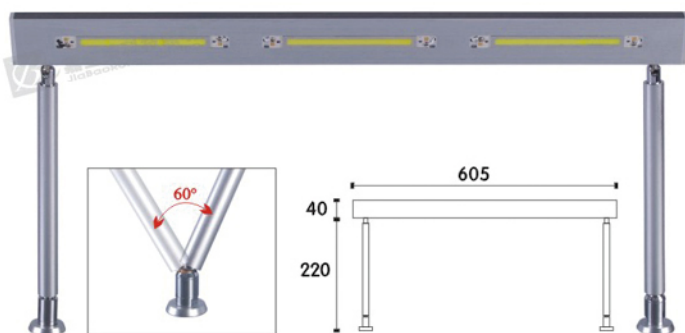

DL-13801

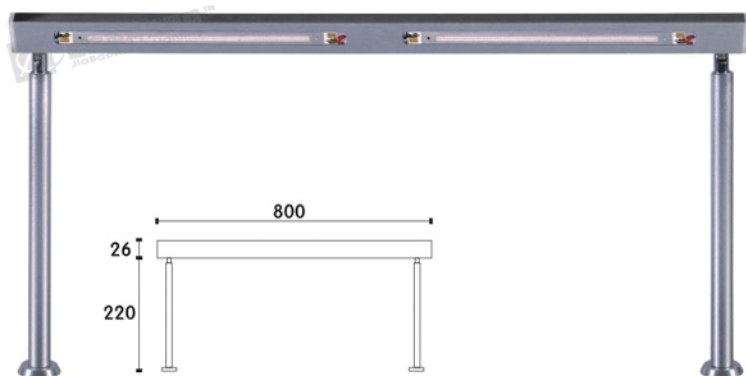

DL-13802



產品型號 Model	DL-13801	DL-13802
燈具功率 LED power	3W x 3	8W x 2
輸入電壓 Input Voltage	AC100~240V	AC100~240V
顯色指數 Color Rendering Index	Ra≥80	Ra≥80
色溫 Color.t	3000~6000K	3000~6000K
外殼材質 Case Material	鋁材 Aluminum	鋁材 Aluminum
發光顏色 Emitting color	白光 / 暖白	白光 / 暖白

# HB40X 智能電流表

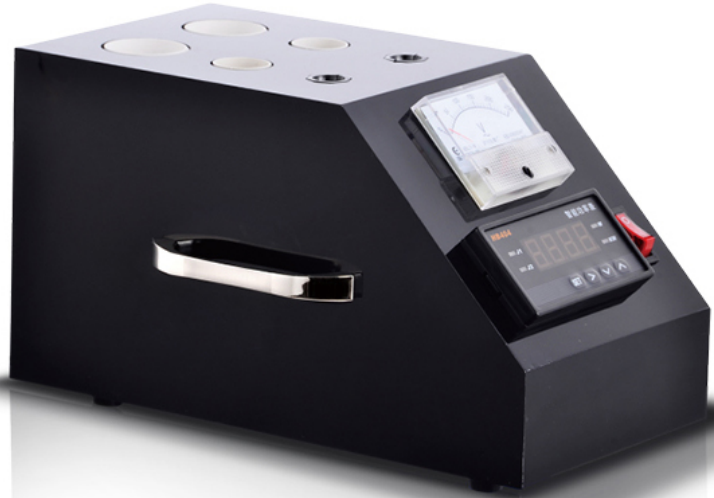

DL-13011

## ✦ 主要技術指標

1. 工作電源：AC85~260V(DC85~360V)/3W
2. 顯示範圍：直流：-1999~9999；交流：0-9999
3. 測量精度：直流：±0.8%；交流：±1.0%+5d
4. 相應頻率：40~400Hz
5. 超限顯示：“EEEE”；或“-EEE”
6. 續電器觸點容量：AC220V / 3A
7. 續電器觸點壽命：10<sup>3</sup>次
8. 變送輸出精度：+(0.8%+3d)12位
9. 使用環境：0~+50℃；≤85%RH